

Product catalog

Accessories and Consumables



Your first choice in digital cutting.

ZÜND
swiss cutting systems

Content

1	Original Zünd accessories – the benefits.....	5
1.1	Warranty limitation.....	5
2	Blade.....	7
2.1	General information.....	7
2.2	Overview of blades.....	18
2.3	Product description.....	27
2.4	Wild knives.....	86
3	Router.....	87
3.1	RM-A / RM-A QC / RM-A QC ARC / RM-S / R45-s.....	87
3.2	URT 300 W / PN 150/450 W.....	94
4	Creasing wheels.....	99
4.1	Creasing wheels type 1.....	99
4.2	Creasing wheels type 2.....	100
4.3	Creasing wheels type 3.....	104
5	Punching tools.....	105
5.1	HSS punches.....	105
5.2	Carbide punches.....	106
5.3	Punching pins.....	106
6	Tools [insert sleeves].....	107
7	Cutting accessories.....	108
7.1	Blade holder, flat-stock drag blade.....	109
7.2	Blade holder, V-cut blade.....	110
7.3	Blade holder, PPT blade.....	112
7.4	EOT.....	113
7.5	EOT-250.....	114
7.6	Glide shoes.....	115
7.7	KCM-S, C2-, C2-P tool heads.....	118

Imprint

Catalog version 12/2015
Author Marketing & Communications, Zünd Systemtechnik AG
Copyright Zünd Systemtechnik AG

8	Routing accessories	119
8.1	Collets, 1 kW milling spindle	119
8.2	Collets, 1 kW milling spindle, QC	119
8.3	Collets, 300 W milling spindle	119
8.4	Collets, 150/450 W milling spindle	120
8.5	Consumables	121
9	Plotting accessories	123
9.1	Insert sleeves, cartridges/cartridge holders	123
9.2	Cartridges	124
9.3	Ink pens	124
10	Cutting and routing underlays	125
10.1	Sealgrip routing underlay	125
10.2	G3 series	125
10.3	S3 series	126
10.4	L3 series	126
10.5	PN series	127
10.6	LC series	132
10.7	P series	134
10.8	Bulk materials	135
11	Conveyor belts	136
11.1	Accessories	136
11.2	G3 series	136
11.3	S3 series	142
11.4	D3 series	144
11.5	PN series	146

1 Original Zünd accessories – the benefits

For us, perfection is about fulfilling our customers' wishes. Whatever the application, you will find the right tool in our Accessories Product Catalogue. Our customers' feedback on our 10,000+ installed systems is constantly being incorporated in the initial and further development of our accessories. This is how we ensure that our products constantly remain at the highest level. We always take note of requirements arising from the application of our systems by our customers, and these are constantly incorporated into the range in the form of new or improved products.

As a quality-conscious customer, you benefit from this commitment by being able to make optimum use of your Zünd cutter in terms of productivity and quality.

Rapid availability of high quality replacement parts is a decisive factor in daily operations. Only a manufacturer with a worldwide presence like Zünd can supply original accessories in such little time on a global scale. And if you don't have a catalogue to hand, you can also find all our accessories online at: www.zund.com.

1.1 Warranty limitation

The type of tool used for any given operation can greatly affect cut quality. Forces and vibrations that occur during processing reduce both the life-cycle of tools (EOT, POT, PRT, DRT, URT etc.) and the cut quality.

The combination of Zünd cutters, Zünd tools and Zünd original accessories is the result of many years' intensive development work. This includes continuous input from our customers and their applications. Zünd reserves the right to refuse warranty claims for defects in Zünd cutters caused by the use of non-original Zünd accessories.

2 Blade

2.1 General information

2.1.1 Benefits at a glance

Zünd offers a broad range of quality blades, specially adapted to your cutting system and suitable for all your needs. This enables you to achieve a consistently high quality standard throughout the entire production process. Zünd blades are developed and manufactured specially by experts to meet market requirements.

Zünd blades offer crucial benefits:

- An excellent cutting result
- Low levels of waste/scrap
- Higher capacity utilization and shorter order times thanks to fewer blade changes
- We use only high performance materials
- Our quality remains constant

Original Zünd quality

Zünd blades are produced to the highest quality standards. All Zünd blades are recognizable through the Zünd quality seal with which they are engraved.



- 1 Zünd quality seal
- 2 Batch number
- 3 Blade name

2.1.2 Blade material

The material the blades are made from plays a major role with regard to the stability and the life expectancy of the blade. Zünd blades are made from carbide or high speed steel. Carbide blades have a significantly higher life expectancy than high speed steel blades, but high speed steel blades are much less susceptible to impacts and vibrations that can cause the tips to break.

**Tip!**

Never touch carbide blades or bring them into contact with hard objects.

The overcut is listed in the Zünd blade catalogue. Compare overcuts to work out which blade is right for you. Detailed information on each blade can be found in the additional specifications.

The benefits of Zünd carbide blades:

- Longer life expectancy than high speed steel.
- Greater productivity thanks to fewer blade changes.
- Better cutting quality thanks to the blade's precision finish and very high stability.

Your Zünd service partners will be pleased to help you choose the best blade for your needs.

2.1.3 Blade shape and dimensions

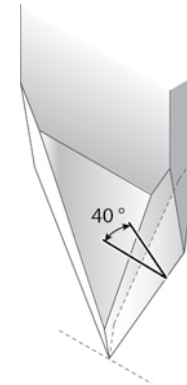
Wedge angle

The wedge angle determines the sharpness of the blade. In theory, a very narrow wedge angle means a very sharp blade that exerts very little drag force on the material. However, a narrow wedge angle also results in considerable force being exerted on the blade. The narrower the wedge angle, the more unstable the blade becomes. For this reason, the wedge angle is always a compromise between sharpness and stability. Zünd blades are specifically designed and sharpened to handle a wide range of materials. The additional specifications provided for each blade contain a list of the materials for which it can be used.

Cutting angle

The cutting angle also has a major influence on the cutting force. With drag blades, a narrow cutting angle means smaller drag forces.

However, this has the disadvantage of creating a larger overcut.

Drag blades



Oscillating blade – flat



Oscillating blade – pointed



Maximum cutting depth

There is a specified maximum cutting depth for each blade, which is determined by the length of the cutting edge. The cutting depth which can be achieved depends greatly on the Type of material. The cutting depth of some oscillating blades will be reduced when using the glide shoe. Please remember to factor in the set depth as well as the material thickness.

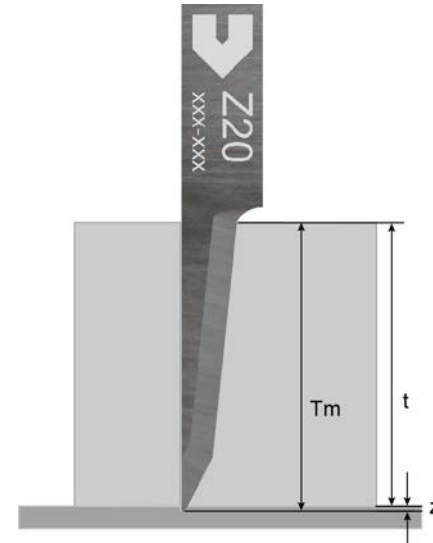

t Material thickness

z Set depth

Tm Cutting depth = material thickness t + set depth z

Overcut x

The pre-cut: x_1 is the distance from the centre of the axis of rotation to the first point where the cutting edge cuts the material surface in the direction of travel. The Post-cut: x_2 is the measurement from the centre of the axis of rotation to the last point where the cutting edge cuts the material surface.

The cutting angle has the greatest influence on processing quality. A narrower cutting angle may enable faster cutting, but it also produces a greater overcut. A narrower cutting angle can be used for paths that include large curves and long straight sections.

**Tip!**

The overcut distorts the cutting contours. For cuts with a low margin of error, Zünd recommends choosing a blade with a smaller overcut. Overcut information can be found in the additional specifications for each blade.

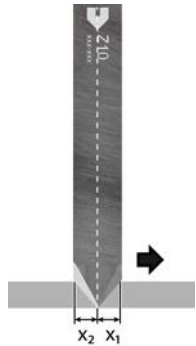
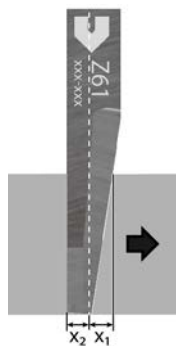
Drag blades**Oscillating blade – flat****Oscillating blade – pointed****Calculating the overcut**

Depending on the cutting depth, the blade geometry will produce a different level of overcut. This chapter explains how to calculate your overcut based on the blade you are using and the material you are cutting. The Z20 pointed oscillating blade and Z11 drag blade are used as examples here.

The cutting depth T_m is made up of the material thickness t and the set depth z . Insert these values into the formula as they are listed in the product description for each blade. The result will be the pre-cut/post-cut: in mm.

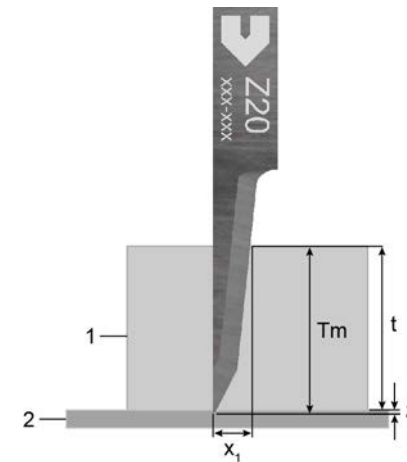
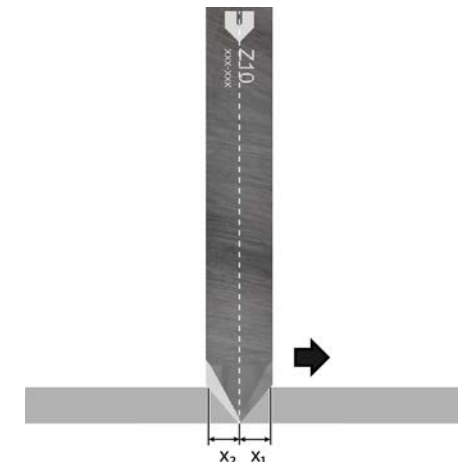
Example Z20**Example Z11**

- 1 Material
- 2 Cutting underlay
- t Material thickness
- z Set depth
- T_m Cutting depth = material thickness t + set depth z
- x_1 Pre-cut
- x_2 Post-cut

Sample calculation Z20

Formula $x = 1.2 + 0.11 \times T_m$

Cutting depth $T_m = 10.2 \text{ mm}$

Pre-cut: $x_1 = 2.322 \text{ mm}$

Sample calculation Z11

Formula $x_{1,2} = 0.58 \times T_m$

Cutting depth $T_m = 5,2 \text{ mm}$

Pre-cut: $x_1 = 3.016 \text{ mm}$

Post-cut: $x_2 = 3.016 \text{ mm}$

2.1.4 Blade Types

Depending on which tool they are used in, a distinction is made between the following blade Types:

- **Drag blades:** used in non-powered tools such as UCT, KCT, VCT, SCT, C2, insert sleeve 40)
- **Oscillating blades:** used in EOT/POT oscillating tools
- **Rotary blade:** decagonal (ten-sided) blades for DRT/PRT tools

Drag blades

Drag knives are used in combination with non-powered tools (UCT, KCT, VCT, SCT, C2).

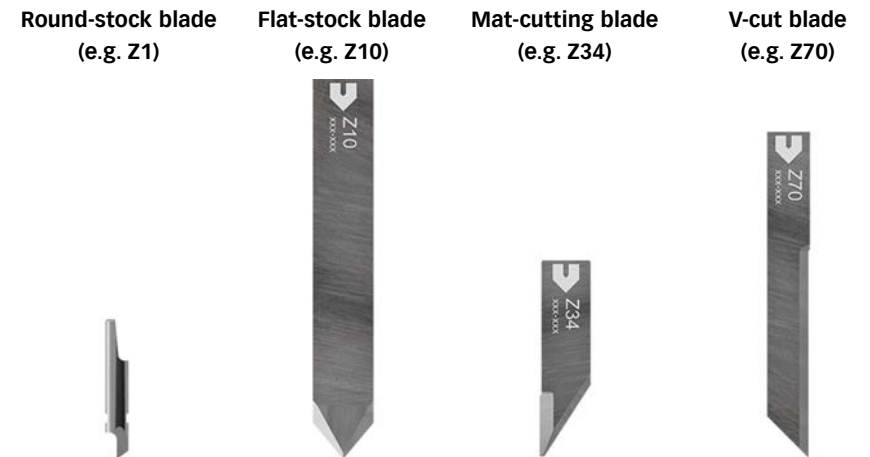

- Maximum cutting speed; cheap to purchase and maintain
- High cutting force
- Particularly suitable for foils, paper, thin folding carton, banners, etc.
- Most cost-effective cutting option, as the purchase price for the associated tools (UCT, KCT, VCT, SCT, C2) is considerably lower than those for powered tools.

Oscillating blades

The oscillating tool is mostly recommended for cutting thick and tough materials. The oscillating motion of the blade decreases the drag force exerted on the material in the direction of travel. However, to achieve this, the feed speed must be precisely adjusted to suit the selected oscillating blade and oscillation frequency. Choosing the right oscillating blade depends primarily on the contour to be cut:

- Zünd recommends flat blades for large radii, straight and large parts.
- Very sharp, pointed blades should only be used to cut small radii. The feed speed must be reduced to achieve a good quality cut.

Flat blade (e.g. Z43)

- High cutting speed
- Large radii, straight and/or large parts

Pointed blade (e.g. Z20)

- Low cutting speed
- Small radii and/or small parts







Rotary blade**Decagonal (ten-sided) blades**

- Very high cutting speed
- Suitable for large radii, straight and/or large parts
- Recommended for breathable materials such as textile, carbon fibre, glass fibre, etc.
- Very large overcut











2.2 Overview of blades

2.2.1 Drag blades

Round-stock blades (C2, C2P, KCT, KCM-S)

Figure	Item no.	Blade	Cutting depth [mm]	Pack. unit (pcs.)	Page
	3910105	Z1	1.0	1	27
	3910110	Z2	1.0	1	28
	3910115	Z3	1.0	1	29
	3910116	Z4	2.1	1	30
	3910154	W6	2.4	1	31
	3910117	Z5	2.6	1	32



Flat-stock blades (UCT, SCT, insert sleeve 40)

Figure	Item no.	Blade	Cutting depth [mm]	Pack. unit (pcs.)	Page
	3910303	Zünd Type 3	2.4/7.9	10	
	3910302	Zünd Type 2	2.7/4.9	10	
	5206878	Z83	4.6	1	34
	3910301	Z10	4.8	1	33
	3910309	Z11	6.9	1	35
	3910310	Zünd Type 6	6.5	10	
	3910306	Z16	7.4	1	36
	3910307	Z17	12	1	37
	3910340	Z44	14.0	1	38
	4800073	Z46	20.0	1	39

Blade

Overview of blades





V-cut blades

Figure	Item no.	Blade	Cutting depth [mm]	Pack. unit (pcs.)	Page
	5005642	Z70	10.0/ 15.6	1	40
	5006045	Z71	16.0/ 18.4	1	41
	5005572	Z73	16.0/ 18.2	5	42

Blade

Overview of blades

Mat-cutting blades (PPT)

Figure	Item no.	Blade	Cutting depth [mm]	Pack. unit (pcs.)	Page
	3910330	Z30	2.0	1	43
	3910331	Z31	2.0	1	44
	3910333	Z33	5.0	1	45
	3910334	Z34	5.0	1	46
	4800071	Z35	5.0	1	47

2.2.2 Oscillating blades

Oscillating blade – pointed























Figure	Item no.	Blade	Cutting depth [mm]	Pack. unit (pcs.)	Page
	3910310	Zünd Type 6	6.5	10	
	3910306	Z16	7.4	1	48
	3910307	Z17	12	1	49
	3910315	Z22	14.0	1	50
	3910313	Z20	14.3	1	51
	5201345	Z60	16.5	1	52
	3910314	Z21	17.2	1	53
	5005560	Z23	22.0	1	54
	3910318	Z28	26.0	1	55
	3910319	Z29	31.0	1	56





Figure	Item no.	Blade	Cutting depth [mm]	Pack. unit (pcs.)	Page
	5200479	Z66	55.0	1	57
	5210315	Z608	56.0	1	58
	5210312	Z606	72.0	1	59
	5210310	Z604	92.0	1	60
	5210306	Z602	112.0	1	61

Oscillating blade – flat

Figure	Item no.	Blade	Cutting depth [mm]	Pack. unit (pcs.)	Page
	3910324	Z42	7.8	1	62
	5203005	Z42-C	7.8	1	63
	3910325	Z43	7.8	1	64
	3910317	Z26	8.7	1	65
	5205519	Z82	9.3	1	66
	3910323	Z41	11.3	1	67
	5002488	Z62	13.2	1	68
	5209985	Z202	14.5	1	69
	5210145	Z203	17.0	1	70
	5209201	Z201	17.4	1	71
	5201343	Z61	20.0	1	72

Figure	Item no.	Blade	Cutting depth [mm]	Pack. unit (pcs.)	Page
	5002637	Z63	28.0	1	73
	5204301	Z68	29.0	1	74
	5204302	Z69	35.0	1	75
	5210317	Z607	56.0	1	76
	5002739	Z64	57.0	1	77
	5210319	Z605	72.0	1	78
	5210320	Z603	92.0	1	79
	5209223	Z601	112.0	1	80

2.2.3 Rotary blade

Figure	Item no.	Blade	Cutting depth [mm]	Pack. unit (pcs.)	Page
	3910335	Z50	3.5	1	81
	3910336	Z51	5.0	1	82
	3910337	Z52	7.0	1	83
	4800059	Z53	2.0	1	84

2.2.4 Wheel knives

Figure	Item no.	Blade	Cutting depth [mm]	Pack. unit (pcs.)	Page
	5205751	Z55	1	1	85

2.3 Product description

2.3.1 Drag blades

Z1

Item no.: 3910105

Type

Round-stock drag blade

Properties

Blade for cutting any standard self-adhesive vinyls.

Recommended materials

- Self-adhesive vinyls
- Masking film
- Cardstock
- Pattern materials

Technical information

Pre-cut: 1.43 x Tm

Post-cut: -

Max. cutting depth: 1.0 mm

Blade material: Carbide

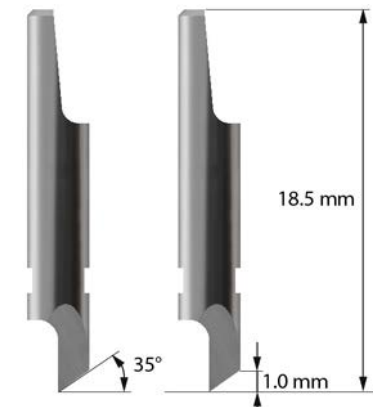

Intended use

KCT,
Insert sleeve 40
for vinyl blades

C2, C2P



KCM-S

Z2**Item no.:** 3910110**Type**

Round-stock drag blade

Technical information

Pre-cut: 1.43 x Tm

Post-cut: -

Max. cutting depth: 1.0 mm

Blade material: Carbide

Properties

Blade for cutting any standard self-adhesive vinyls. Similar to the Z1, but exerts less drag force and has a shorter life expectancy.

Recommended materials

- Reflective vinyls
- Self-adhesive vinyls
- Masking film
- Cardstock
- Pattern materials

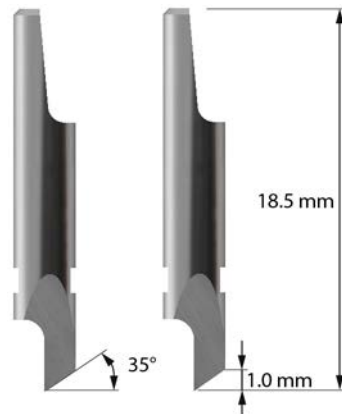
**Intended use**

KCT,
Insert sleeve 40
for vinyl blades



C2, C2P



KCM-S

Z3**Item no.:** 3910115**Type**

Round-stock drag blade

Technical information

Pre-cut: 1.43 x Tm

Post-cut: 1.43 x Tm

Max. cutting depth: 1.0 mm

Blade material: Carbide

Properties

Fine blade for creating small lettering.
Stable and long-life double-edged blade.

Recommended materials

- Self-adhesive vinyls
- Masking film

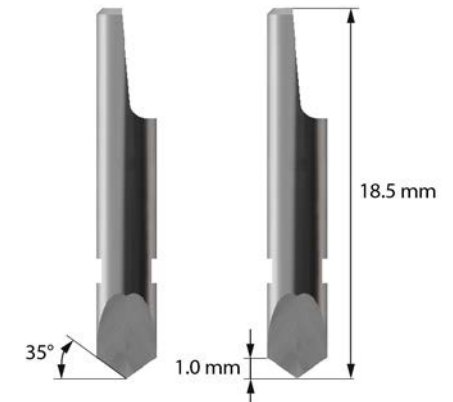
**Intended use**

KCT,
Insert sleeve 40
for vinyl blades



C2, C2P



KCM-S

Z4**Item no.:** 3910116**Type**

Round-stock drag blade

Properties

Fine blade tip with small overcut;
therefore somewhat less stable.

Recommended materials

- Sandblast vinyls
- Reflective vinyls
- Cardstock
- Pattern materials

Technical information

Pre-cut: 0.7 x Tm

Post-cut: -

Max. cutting depth: 2.1 mm

Blade material: Carbide

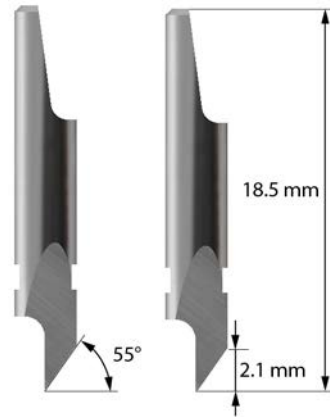
**Intended use**

KCT,
Insert sleeve 40
for vinyl blades



C2, C2P



KCM-S

W6**Item no.:** 3910154**Type**

Round-stock drag blade

Properties

Robust all-round blade which exerts little
drag force for large radii.

Recommended materials

- Paper
- Cardstock
- Tarpaulin material
- Plastic film

Technical information

Pre-cut: 1.73 x Tm

Post-cut: -

Max. cutting depth: 2.4 mm

Blade material: Carbide

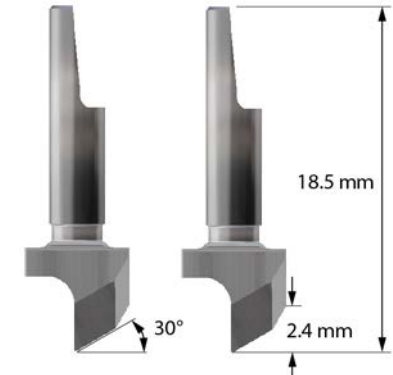
**Intended use**

KCT,
Insert sleeve 40
for vinyl blades



C2, C2P



KCM-S

Z5**Item no.:** 3910117**Type**

Round-stock drag blade

Properties

Very small overcut for vinyls and soft materials.

Recommended materials

- Sandblast vinyls
- Reflective vinyls
- Cardstock
- Pattern materials

Technical information

Pre-cut: 0.58 x Tm

Post-cut: -

Max. cutting depth: 2.6 mm

Blade material: Carbide

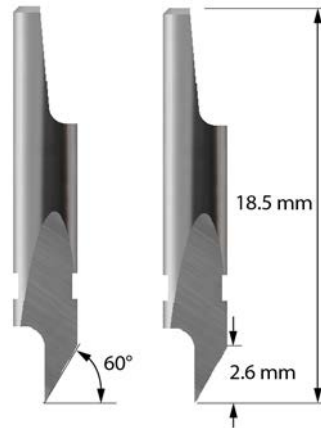
**Intended use**

KCT,
Insert sleeve 40
for vinyl blades



C2, C2P



KCM-S

Z10**Item no.:** 3910301**Type**

Flat-stock drag blade

Properties

Stable and robust double-edged drag blade. Similar to Z11, but with a larger overcut and longer life expectancy.

Recommended materials

- Tarpaulin material
- PVC banners (frontlit/backlit)
- Polypropylene materials
- Polyester fabric; coated textiles
- Polycarbonate; PC
- Folding carton; 100 - 1500 g
- Vinyl
- Hard foam core

Technical information

Pre-cut: 0.84 x Tm

Post-cut: 0.84 x Tm

Max. cutting depth: 4.8 mm

Blade thickness: 1.5 mm

Blade material: Carbide

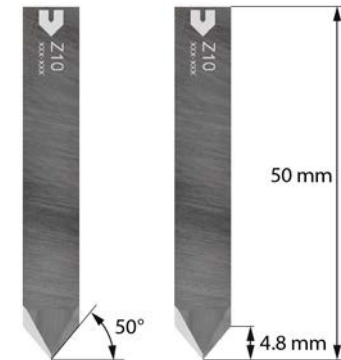
**Intended use**

UCT,
Insert sleeve 40 +
blade holder type 1
(3960322)



SCT +
blade holder type 1
(3960322)

Z83**Item no.:** 5206878**Type**

Flat-stock drag blade

Properties

Centric, asymmetrical drag blade for ridgefree inside cutting edge.

Recommended materials

- PVC
- Polycarbonate; PC
- Folding carton
- Hard foam core

Technical information

Pre-cut: 0.84 x Tm

Post-cut: 0.84 x Tm

Max. cutting depth: 4.6 mm

Blade thickness: 1.5 mm

Blade material: Carbide

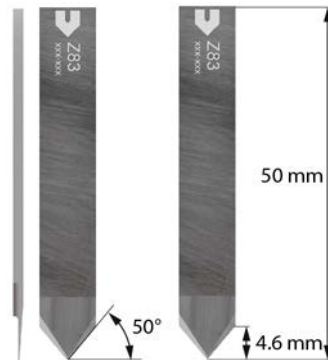
**Intended use**

UCT,
Insert sleeve 40 +
blade holder type 1
(3960322)



SCT +
blade holder type 1
(3960322)

Z11**Item no.:** 3910309**Type**

Flat-stock drag blade

Properties

Double-edged blade with universal applications. Similar to Z10, but with a smaller overcut and shorter life expectancy.

Recommended materials

- Tarpaulin material
- PVC banners (frontlit/backlit)
- Polypropylene materials
- Polyester fabric; coated textiles
- Polycarbonate
- Folding carton; 100 - 1500 g
- Vinyl
- Hard foam core

Technical information

Pre-cut: 0.58 x Tm

Post-cut: 0.58 x Tm

Max. cutting depth: 6.9 mm

Blade thickness: 1.5 mm

Blade material: Carbide

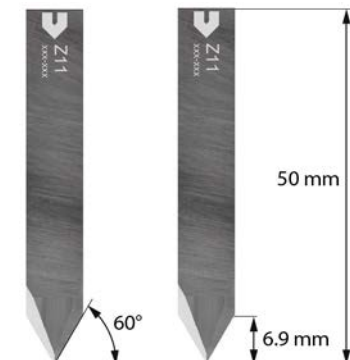
**Intended use**

UCT,
Insert sleeve 40 +
blade holder type 1
(3960322)



SCT +
blade holder type 1
(3960322)

Z16**Item no.:** 3910306**Type**Flat-stock drag blade/
Oscillating blade – pointed**Properties**Blade for soft materials. Universally
applicable as a robust oscillating blade.**Recommended materials**

- Magnetic material
- Polycarbonate
- Polyester film
- Coating blanket
- Paper; 100 - 400 g
- Folding carton; 100 - 1500 g

Technical information

Pre-cut: 0.73 x Tm

Post-cut: -

Max. cutting depth: 7.4 mm

Blade thickness: 0.63 mm

Blade material: Carbide

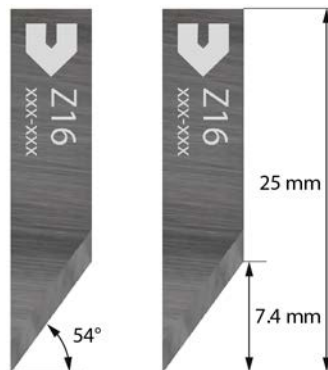
**Intended use**UCT,
Insert sleeve 40 +
blade holder type 3
(3960324)SCT +
blade holder type 3
(3960324)**Z17****Item no.:** 3910307**Type**Flat-stock drag blade/
Oscillating blade – pointed**Properties**Blade for cutting thin materials. The
overcut is smaller, but the blade exerts
more drag force on the material than the
Z16. For best results, use as an oscillating
blade.**Recommended materials**

- Magnetic material
- Polycarbonate
- Polyester film
- Coating blanket
- Paper; 100 - 400 g
- Folding carton; 100 - 1500 g

Technical information

Pre-cut: 0.47 x Tm

Post-cut: -

Max. cutting depth: 12 mm

Blade thickness: 0.63 mm

Blade material: Carbide

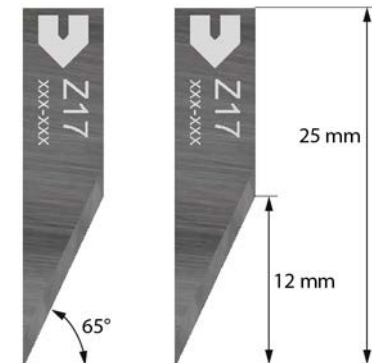
**Intended use**UCT,
Insert sleeve 40 +
blade holder type 3
(3960324)SCT +
blade holder type 3
(3960324)

Z44

Item no.: 3910340

Type

Flat-stock drag blade

Properties

Double-sided blade for less tough, fibrous materials. This blade offers similar properties to Z11.

Recommended materials

- Carpet
- Tarpaulin material

Technical information

Pre-cut: 0.58 x Tm

Post-cut: 0.58 x Tm

Max. cutting depth: 14 mm

Blade thickness: 1.5 mm

Blade material: Carbide

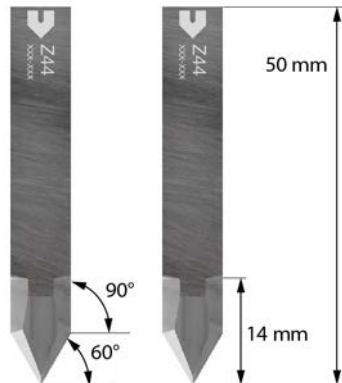
**Intended use**

UCT,
Insert sleeve 40 +
blade holder type 1
(3960322)



SCT +
blade holder type 1
(3960322)

Z46

Item no.: 4800073

Type

Flat-stock drag blade

Properties

Blade for light, soft materials. Exerts little drag force, but has a larger overcut.

Recommended materials

- Carpet
- Corrugated plastic
- Light foam core
- PVC banners (frontlit/backlit)

Technical information

Pre-cut: 1.0 x Tm

Post-cut: -

Max. cutting depth: 20 mm

Blade thickness: 1.5 mm

Blade material: Carbide

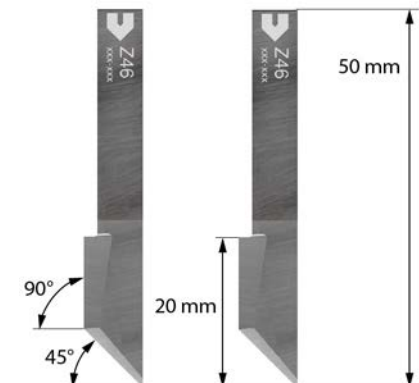
**Intended use**

UCT,
Insert sleeve 40 +
blade holder type 5
(3960320)



SCT +
blade holder type 5
(3960320)

Z70

Item no.: 5005642

Type

V-cut drag blade

Properties

Blade for a 45° cut.

Recommended materials

- Corrugated cardboard, sandwich board
- Light foam core
- Corrugated cardboard – BCA flute
- Carpet
- Corrugated plastic

Technical information

Max. cutting depth:

3102186: 15.6 mm

5005782: 11.9 mm

Blade thickness: 0.63 mm

Blade material: Carbide

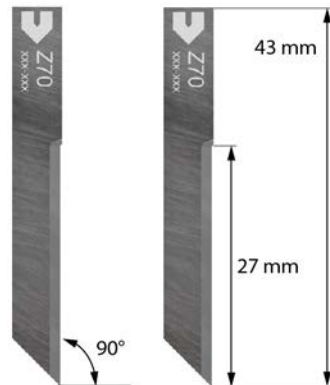
**Intended use**

T75 +

Use for V-cut (3102186),
blade holder (5005782)**Z71**

Item no.: 5005645

Type

V-cut drag blade

Properties

Stable, long-life carbide blade.

Recommended materials

- Corrugated cardboard, sandwich board
- Light foam core
- Corrugated cardboard – BCA flute
- Carpet
- Corrugated plastic

Technical information

Max. cutting depth:

5206263: 11.8 mm

5206264: 18.4 mm

Blade thickness: 1 mm

Blade material: Carbide

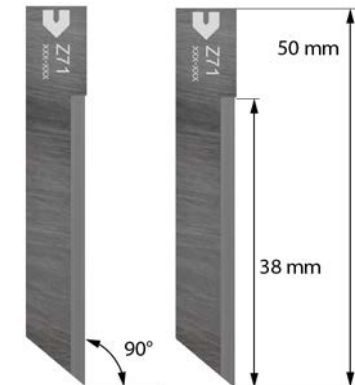
**Intended use**

VCT +

blade holder; up to
10 mm cutting depth
(5206263)

VCT +

blade holder; up to
16 mm cutting depth
(5206264)

Z73

Item no.: 5005572

Type

V-cut drag blade

Technical information

Max. cutting depth:
blade holder: 18.2 mm
Use for V-cut: 18.2 mm
Blade thickness: 0.9 mm
Blade material: HSS

Properties

Stable high speed steel blade

Recommended materials

- Corrugated cardboard, sandwich board
- Light foam core
- Corrugated cardboard – BCA flute
- Carpet
- Corrugated plastic

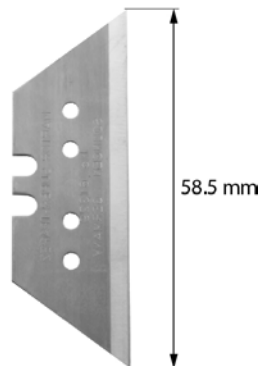
**Intended use**

VCT +
blade holder; up to
16 mm cutting depth
(5206262)



T75 +
Use for V-cut
(3102186)

Z30

Item no.: 3910330

Type

Mat-cutting blade

Technical information

Max. cutting depth: 2 mm
Blade thickness: 0.63 mm
Blade material: Carbide

Properties

Small mat-cutting blade for cutting straight
lines and sharp corners from the back of
the matboard.

Recommended materials

- Matboard

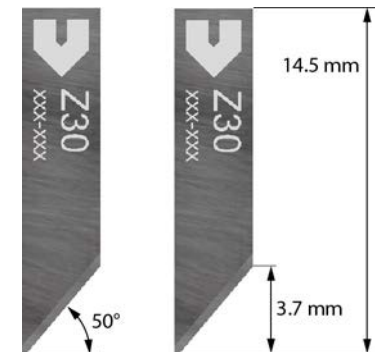
**Intended use**

PPT +
blade holder; up to
2 mm cutting depth
(3960331)

Z31**Item no.:** 3910331**Type**

Mat-cutting blade

Technical information

Max. cutting depth: 2 mm

Blade thickness: 0.63 mm

Blade material: Carbide

Properties

Small mat-cutting blade; multifunctional with two cutting edges to cut straight lines from the back of the matboard and radii from the front of the matboard.

Recommended materials

– Matboard

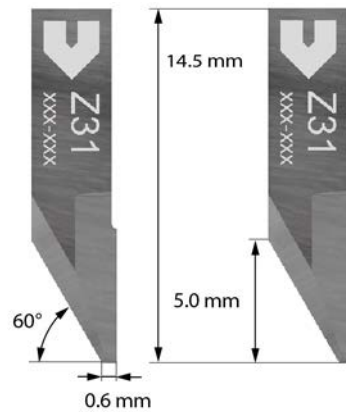
**Intended use**

PPT +
blade holder; up to
2 mm cutting depth
(3960331)

Z33**Item no.:** 3910333**Type**

Mat-cutting blade

Technical information

Max. cutting depth: 5 mm

Blade thickness: 0.63 mm

Blade material: Carbide

Properties

Large mat-cutting blade for cutting straight lines and sharp corners on the back of the matboard.

Recommended materials

– Matboard

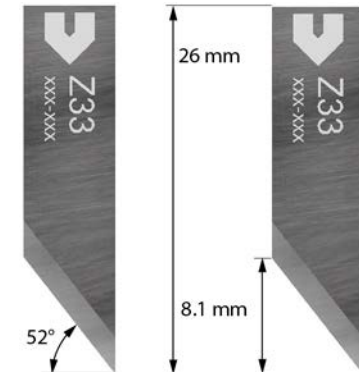
**Intended use**

PPT +
blade holder; up to
5 mm cutting depth
(3960328)

Z34**Item no.:** 3910334**Type**

Mat-cutting blade

Technical information

Max. cutting depth: 5 mm

Blade thickness: 0.63 mm

Blade material: Carbide

Properties

Large mat-cutting blade; multifunctional with two cutting edges to cut straight lines from the back of the matboard and radii from the front of the matboard.

Recommended materials

– Matboard

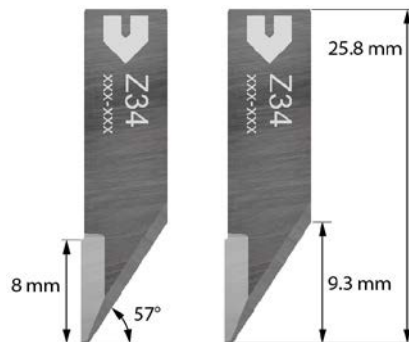
**Intended use**

PPT +
blade holder; up to
5 mm cutting depth
(3960328)



PPT +
blade holder; up
to 2.5 mm cutting
depth (3960329)

Z35**Item no.:** 4800071**Type**

Mat-cutting blade

Technical information

Max. cutting depth: 5 mm

Blade thickness: 0.63 mm

Blade material: Carbide

Properties

Large mat-cutting blade for cutting straight lines and sharp corners from the front of the matboard.

Recommended materials

– Matboard

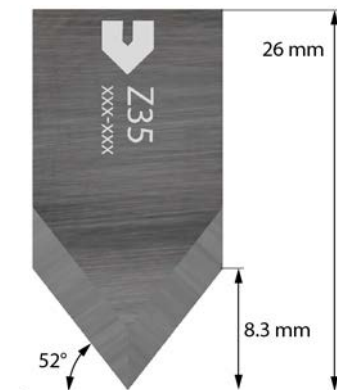
**Intended use**

PPT +
blade holder; up to
5 mm cutting depth
(3960330)

2.3.2 Oscillating blades

Z16

Item no.: 3910306

Type

Flat-stock drag blade/
Oscillating blade – pointed

Properties

For soft materials. Universally applicable as
a robust oscillating blade.

Recommended materials

- Folding carton; 100 - 1500 g
- Gasket materials
- Foam
- Leather

Technical information

Pre-cut: 0.73 x Tm
Post-cut: -
Max. cutting depth: 7.4 mm
Blade thickness: 0.63 mm
Blade material: Carbide

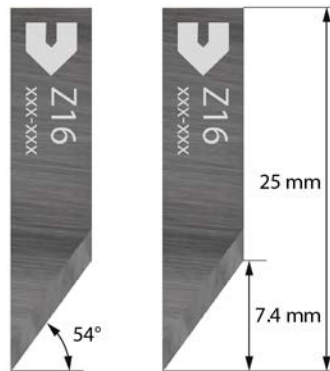

Intended use



EOT

EOT-250 +
blade holder
(5208744)POT,
blade holder
0.63 mmPOT, blade holder
1.5 mm +
blade reduction 1.5/
0.63 mm (5003138)

Z17

Item no.: 3910307

Type

Flat-stock drag blade/
Oscillating blade – pointed

Properties

Blade for cutting thin materials. The overcut
is smaller, but the blade exerts more
drag force than the Z16. For best results,
use as an oscillating blade.

Recommended materials

- Folding carton; 100 - 1500 g
- Gasket materials
- Foam
- Leather

Technical information

Pre-cut: 0.47 x Tm
Post-cut: -
Max. cutting depth: 12 mm
Blade thickness: 0.63 mm
Blade material: Carbide

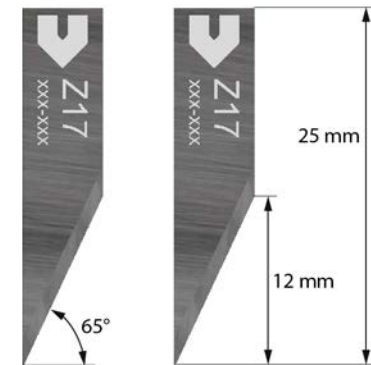

Intended use



EOT

EOT-250 +
blade holder
(5208744)POT,
blade holder
0.63 mmPOT, blade holder
1.5 mm +
blade reduction 1.5/
0.63 mm (5003138)

Z22

Item no.: 3910315

Type

Oscillating blade – pointed

Properties

Fine, robust blade with low overcut; designed to cut small radii and intricate detail. Similar to Z20, but more robust and with a larger overcut.

Recommended materials

- Corrugated cardboard; B, C, BC, EB and E flute
- Light foam core
- Foam
- Folding carton; 100 - 1500 g
- Polyester fabric; coated textiles
- Rubber, ejection rubber
- Magnetic material
- Corrugated plastic
- Felt

Technical information

Pre-cut: 1.2 + 0.2 x Tm

Post-cut: -

Max. cutting depth: 14 mm

Blade thickness: 0.63 mm

Blade material: Carbide

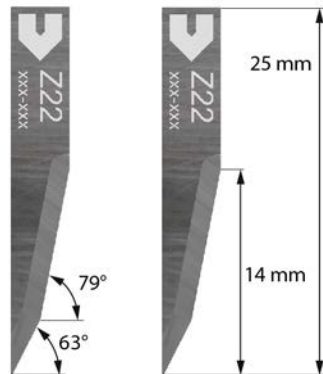
**Intended use**

EOT

EOT-250 +
blade holder
(5208744)POT,
blade holder
0.63 mmPOT, blade holder
1.5 mm +
blade reduction 1.5/
0.63 mm (5003138)**Z20**

Item no.: 3910313

Type

Oscillating blade – pointed

Properties

Very fine, delicate blade with minimal overcut; designed to cut small radii and intricate detail.

Recommended materials

- Corrugated cardboard; B, C, BC, EB and E flute
- Folding carton; 100 - 1500 g
- Light foam core
- Foam
- Ejection rubber
- Felt

Technical information

Pre-cut: 1.2 + 0.11 x Tm

Post-cut: -

Max. cutting depth: 14.3 mm

Blade thickness: 0.63 mm

Blade material: Carbide

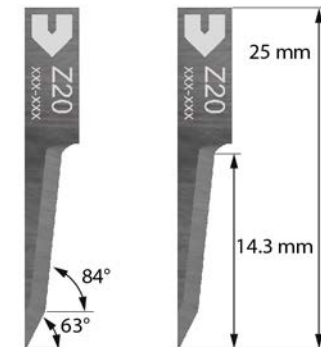
**Intended use**

EOT

EOT-250 +
blade holder
(5208744)POT,
blade holder
0.63 mmPOT, blade holder
1.5 mm +
blade reduction 1.5/
0.63 mm (5003138)

Z60

Item no.: 5201345

Type

Oscillating blade – pointed

Properties

Strong blade for tough materials; similar to Z21.

Recommended materials

- Saddle leather, leather
- Rubber
- Corrugated plastic

Technical information

Pre-cut: 2.2 + 0.15 x Tm
 Post-cut: -
 Max. cutting depth: 16.5 mm
 Blade thickness: 1.5 mm
 Blade material: Carbide

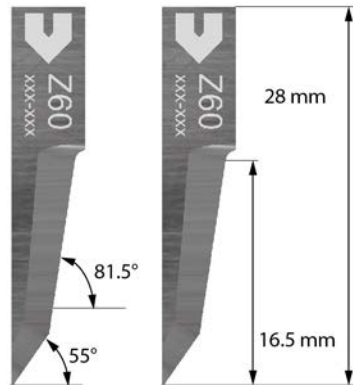

Intended use



EOT-250



POT,
 blade holder
 1.5 mm

Z21

Item no.: 3910314

Type

Oscillating blade – pointed

Properties

Fine blade with low overcut; designed to cut small radii and intricate detail.

Recommended materials

- Corrugated cardboard
- Light foam core
- Foam
- Rubber, ejection rubber
- Felt

Technical information

Pre-cut: 1.6 + 0.11 x Tm
 Post-cut: -
 Max. cutting depth: 17.2 mm
 Blade thickness: 0.63 mm
 Blade material: Carbide

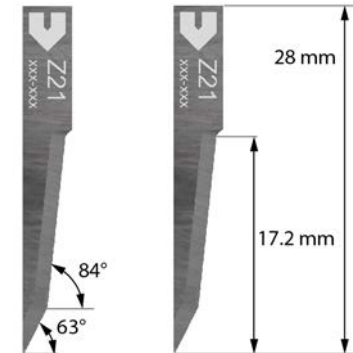

Intended use



EOT



EOT-250 +
 blade holder
 (5208744)



POT,
 blade holder
 0.63 mm



POT, blade holder
 1.5 mm +
 blade reduction 1.5/
 0.63 mm (5003138)

Z23

Item no.: 5005560

Type

Oscillating blade – pointed

Properties

Fine, long blade; designed to cut small radii and intricate detail.

Recommended materials

- Foam
- Insulating mat
- Sandwich board

Technical information

Pre-cut: 1.8 + 0.1 x Tm

Post-cut: -

Max. cutting depth: 22 mm

Blade thickness: 0.63 mm

Blade material: Carbide

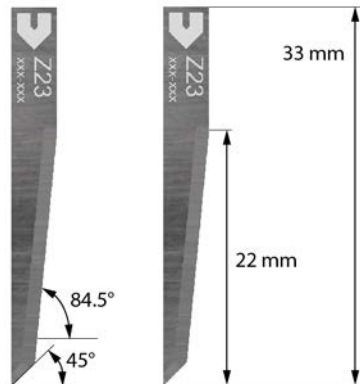
**Intended use**

EOT

EOT-250 +
blade holder
(5208744)POT,
blade holder
0.63 mmPOT, blade holder
1.5 mm +
blade reduction 1.5/
0.63 mm (5003138)**Z28**

Item no.: 3910318

Type

Oscillating blade – pointed

Properties

Long oscillating blade for soft, thick materials.

Recommended materials

- Foam
- Insulating mat

Technical information

Pre-cut: 1.9 + 0.07 x Tm

Post-cut: -

Max. cutting depth: 26 mm

Blade thickness: 0.63 mm

Blade material: Carbide

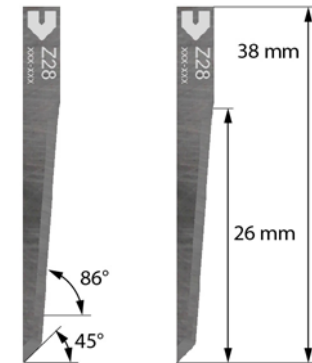
**Intended use**

EOT

EOT-250 +
blade holder
(5208744)POT,
blade holder
0.63 mmPOT, blade holder
1.5 mm +
blade reduction 1.5/
0.63 mm (5003138)

Z29

Item no.: 3910319

Type

Oscillating blade – pointed

Properties

Long oscillating blade for soft, thick materials.
Similar to Z28, but longer.

Recommended materials

- Foam
- Insulating mat

Technical information

Pre-cut: 1.9 + 0.06 x Tm

Post-cut: -

Max. cutting depth: 31 mm

Blade thickness: 0.63 mm

Blade material: Carbide

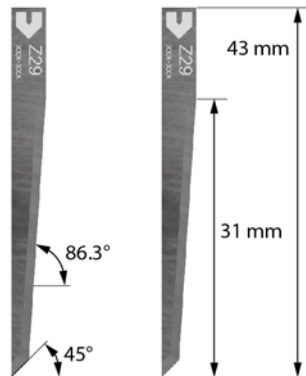
**Z66**

Item no.: 5200479

Type

Oscillating blade – pointed

Properties

Long blade with serrated cutting edge.

Recommended materials

- Foam
- Insulating mat
- Corrugated cardboard – special flute design

Technical information

Pre-cut: 3.9 + 0.04 x Tm

Post-cut: -

Max. cutting depth: 55 mm

Blade thickness: 1.5 mm

Blade material: Carbide

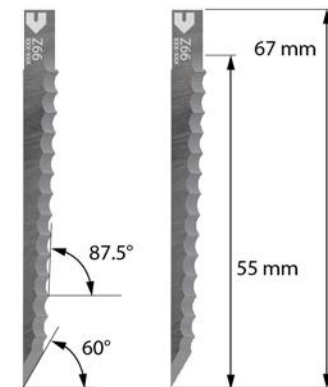
**Intended use**

EOT

EOT-250 +
blade holder
(5208744)POT,
blade holder
0.63 mmPOT, blade holder
1.5 mm +
blade reduction 1.5/
0.63 mm (5003138)**Intended use**POT,
blade holder
1.5 mm

Z608**Item no.:** 5210315**Type**

Oscillating blade – pointed

Properties

Oscillating blade for soft foam up to 54 mm thickness and <math> < 45 \text{ kg/m}^3 </math>

Recommended materials

– Foam

Technical informationPre-cut: $3.8 + 0.03 \times Tm$

Post-cut: -

Max. cutting depth: 56 mm

Blade thickness: 1.5 mm

Blade material: HSS

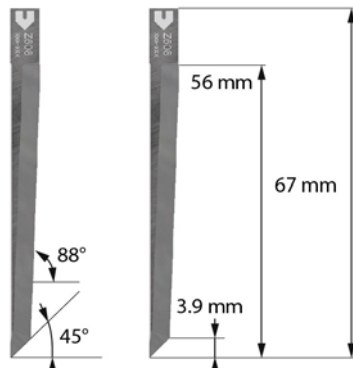
**Intended use**

EOT-250

POT, blade holder 1.5 mm +
gliding disc (5205984) +
spring insert low (3120030)**Z606****Item no.:** 5210312**Type**

Oscillating blade – pointed

Properties

Oscillating blade for soft foam up to 70 mm thickness and <math> < 45 \text{ kg/m}^3 </math>

Recommended materials

– Foam

Technical informationPre-cut: $3.8 + 0.03 \times Tm$

Post-cut: -

Max. cutting depth: 72 mm

Blade thickness: 1.5 mm

Blade material: HSS

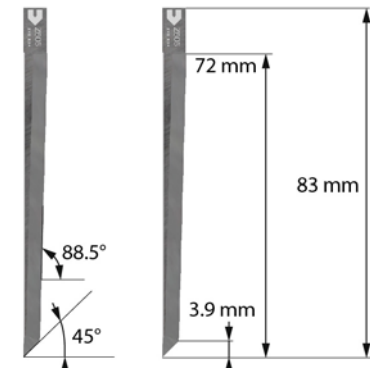
**Intended use**

EOT-250

POT, blade holder 1.5 mm +
gliding disc (5205984) +
spring insert low (3120030)

Z604**Item no.:** 5210310**Type**

Oscillating blade – pointed

Properties

Oscillating blade for soft foam up to 90 mm thickness and <math>< 45 \text{ kg/m}^3</math>

Recommended materials

– Foam

Technical informationPre-cut: $3.8 + 0.02 \times T_m$

Post-cut: -

Max. cutting depth: 92 mm

Blade thickness: 1.5 mm

Blade material: HSS

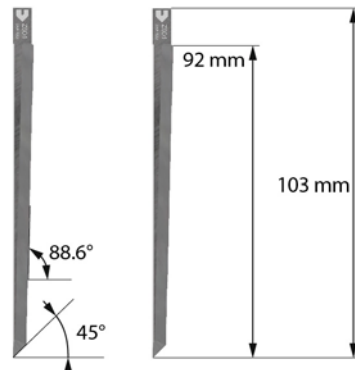
**Intended use**

EOT-250

POT, blade holder 1.5 mm +
gliding disc (5205984) +
spring insert low (3120030)**Z602****Item no.:** 5210306**Type**

Oscillating blade – pointed

Properties

Oscillating blade for soft foam up to 110 mm thickness and <math>< 45 \text{ kg/m}^3</math>

Recommended materials

– Foam

Technical informationPre-cut: $3.8 + 0.02 \times T_m$

Post-cut: -

Max. cutting depth: 112 mm

Blade thickness: 1.5 mm

Blade material: HSS

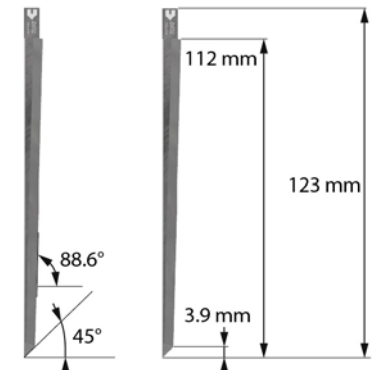
**Intended use**

EOT-250

POT, blade holder 1.5 mm +
gliding disc (5205984) +
spring insert low (3120030)

Z42

Item no.: 3910324

Type

Oscillating blade – flat

Properties

Robust oscillating blade with small pre-cut.
Similar to Z26.

Recommended materials

- Leather
- Woven materials, textiles
- Corrugated cardboard

Technical information

Pre-cut: 0.05 + 0.7 x Tm
Post-cut: 0.80 mm
Max. cutting depth: 7.8 mm
Blade thickness: 0.63 mm
Blade material: Carbide

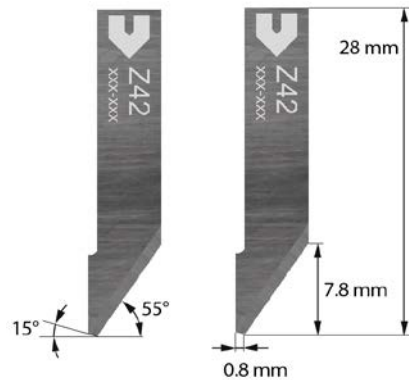

Intended use



EOT

EOT-250 +
blade holder
(5208744)

POT,
blade holder
0.63 mm

POT, blade holder
1.5 mm +
blade reduction 1.5/
0.63 mm (5003138)

Z42c (coated)

Item no.: 5203005

Type

Oscillating blade – flat

Properties

Robust oscillating blade with the same geometry as Z42. The blade is specially coated to increase life expectancy for leather cutting.

Recommended materials

- Leather

Technical information

Pre-cut: 0.05 + 0.7 x Tm
Post-cut: 0.80 mm
Max. cutting depth: 7.8 mm
Blade thickness: 0.63 mm
Blade material: Carbide

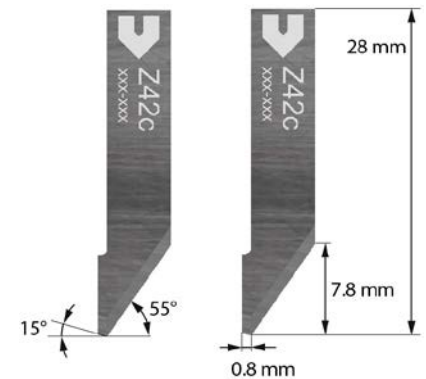

Intended use



EOT

EOT-250 +
blade holder
(5208744)

POT,
blade holder
0.63 mm

POT, blade holder
1.5 mm +
blade reduction 1.5/
0.63 mm (5003138)

Z43

Item no.: 3910325

Type

Oscillating blade – flat

Properties

Robust oscillating blade. Similar to Z42, but with smaller pre-cut and larger postcut.

Recommended materials

- Leather
- Woven materials, textiles
- Corrugated cardboard

Technical informationPre-cut: $-0.8 + 0.7 \times T_m$

Post-cut: 1.55 mm

Max. cutting depth: 7.8 mm

Blade thickness: 0.63 mm

Blade material: Carbide

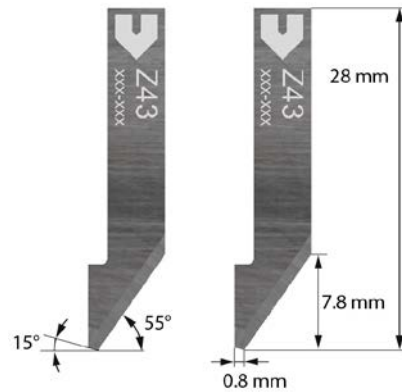
**Intended use**

EOT



EOT-250 +
blade holder
(5208744)



POT,
blade holder
0.63 mm



POT, blade holder
1.5 mm +
blade reduction 1.5/
0.63 mm (5003138)

Z26

Item no.: 3910317

Type

Oscillating blade – flat

Properties

Simple, robust oscillating blade.

Recommended materials

- Woven materials, textiles
- Leather
- Corrugated cardboard
- Felt
- Rubber
- Sandwich board

Technical informationPre-cut: $1.2 + 0.51 \times T_m$

Post-cut: -

Max. cutting depth: 8.7 mm

Blade thickness: 0.63 mm

Blade material: Carbide

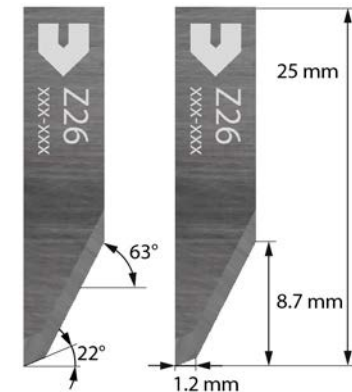
**Intended use**

EOT



EOT-250 +
blade holder
(5208744)



POT,
blade holder
0.63 mm



POT, blade holder
1.5 mm +
blade reduction 1.5/
0.63 mm (5003138)

Z82**Item no.:** 5205519**Type**

Oscillating blade – flat

Properties

Only use with strong cutting underlay (PLP).

Recommended materials

– Reinforced graphite gasket

Technical information

Pre-cut: 2.4 + 0.36 x Tm

Post-cut: -

Max. cutting depth: 9.3 mm

Blade thickness: 1.5 mm

Blade material: Carbide

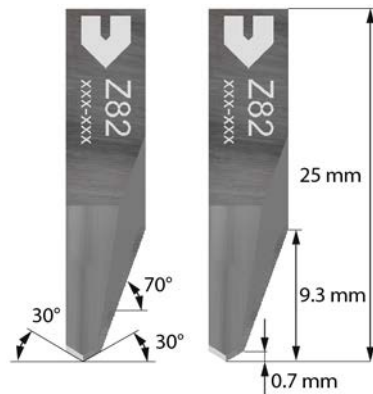
**Intended use**

POT, blade holder 1.5 mm +
gliding disc (5205984) +
spring insert low (3120030)

Z41**Item no.:** 3910323**Type**

Oscillating blade – flat

Properties

Oscillating blade with small pre-cut.

Recommended materials

- Leather
- Corrugated cardboard
- Woven materials, textiles
- Felt
- Foam

Technical information

Pre-cut: 0.8 + 0.18 x Tm

Post-cut: 1.20 mm

Max. cutting depth: 11.3 mm

Blade thickness: 0.63 mm

Blade material: Carbide

**Intended use**

EOT

EOT-250 +
blade holder
(5208744)

POT,
blade holder
0.63 mm

POT, blade holder
1.5 mm +
blade reduction 1.5/
0.63 mm (5003138)

Z62

Item no.: 5002488

Type

Oscillating blade – flat

Properties

Oscillating blade with small pre-cut. Similar to Z41, but longer.

Recommended materials

- Leather
- Corrugated cardboard
- Woven materials, textiles
- Felt
- Foam

Technical information

Pre-cut: 0.8 + 0.18 x Tm

Post-cut: 1.20 mm

Max. cutting depth: 13.2 mm

Blade thickness: 0.63 mm

Blade material: Carbide

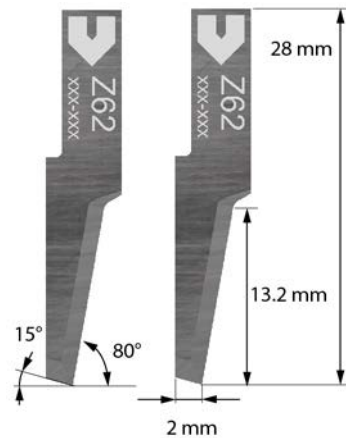
**Z202**

Item no.: 5209985

Type

Oscillating blade – flat

Properties

Oscillating blade with multifaceted bidirectional cutting edge for high-speed cutting of 10 mm paper-based honeycomb/corrugated display board.

Recommended materials

- Corrugated sandwich 10 mm

Technical information

Pre-cut: 5.5 mm

Post-cut: -

Max. cutting depth: 14.5 mm

Blade thickness: 1.5 mm

Blade material: Carbide

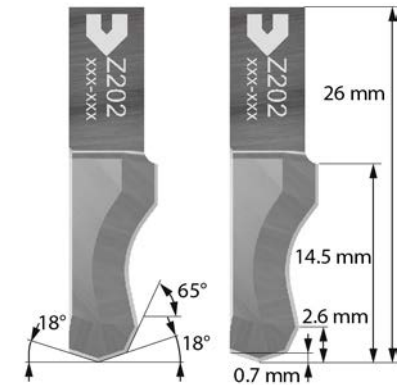
**Intended use**

EOT

EOT-250 +
blade holder
(5208744)POT,
blade holder
0.63 mmPOT, blade holder
1.5 mm +
blade reduction 1.5/
0.63 mm (5003138)**Intended use**

EOT-250

Z203

Item no.: 5210145

Type

Oscillating blade – flat

Properties

Oscillating blade with multifaceted bidirectional cutting edge for high-speed cutting of 12.7 mm paper-based honeycomb/corrugated display board.

Recommended materials

– Corrugated sandwich 12.7 mm

Technical information

Pre-cut: 5.5 mm

Post-cut: -

Max. cutting depth: 17 mm

Blade thickness: 1.5 mm

Blade material: Carbide

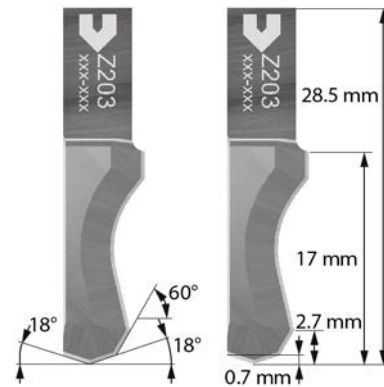
**Intended use**

EOT-250

Z201

Item no.: 5209201

Type

Oscillating blade – flat

Properties

Oscillating blade with multifaceted bidirectional cutting edge for high-speed cutting of 16 mm paper-based honeycomb/corrugated display board.

Recommended materials

– Corrugated sandwich 16 mm

Technical information

Pre-cut: 6.4 mm

Post-cut: -

Max. cutting depth: 17.4 mm

Blade thickness: 1.5 mm

Blade material: Carbide

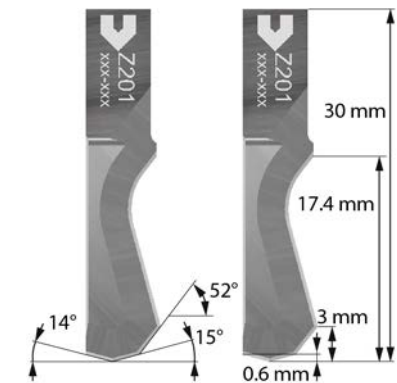
**Intended use**

EOT-250

Z61**Item no.:** 5201343**Type**

Oscillating blade – flat

Properties

Very robust, heavy-duty oscillating blade.

Recommended materials

- Sandwich board
- Corrugated cardboard
- Corrugated plastic

Technical information

Pre-cut: 2.5 + 0.15 x Tm

Post-cut: -

Max. cutting depth: 20 mm

Blade thickness: 1.5 mm

Blade material: Carbide

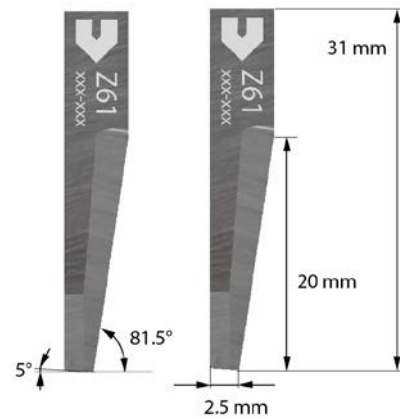
**Intended use**

EOT-250

POT,
blade holder
1.5 mm**Z63****Item no.:** 5002637**Type**

Oscillating blade – flat

Properties

Oscillating blade with small pre-cut. Similar to Z62, but longer and therefore a little less stable.

Recommended materials

- Foam
- Insulating mat

Technical information

Pre-cut: 0.8 + 0.12 x Tm

Post-cut: 1.20 mm

Max. cutting depth: 28 mm

Blade thickness: 0.63 mm

Blade material: Carbide

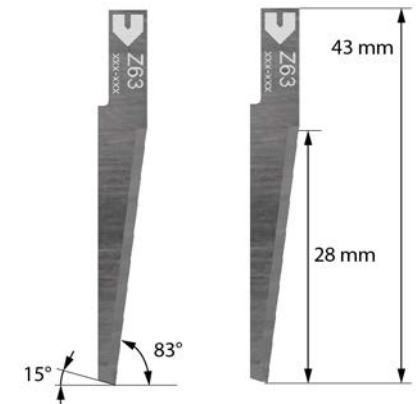
**Intended use**

EOT

EOT-250 +
blade holder
(5208744)POT,
blade holder
0.63 mmPOT, blade holder
1.5 mm +
blade reduction 1.5/
0.63 mm (5003138)

Z68**Item no.:** 5204301**Type**

Oscillating blade – flat

Properties

Blade for sandwich materials

Recommended materials

- Sandwich board
- Corrugated cardboard
- Corrugated plastic

Technical information

Pre-cut: 1.9 + 0.12 x Tm

Post-cut: -

Max. cutting depth: 29 mm

Blade thickness: 1.5 mm

Blade material: Carbide

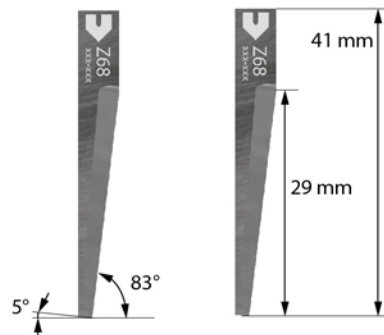
**Intended use**

EOT-250

POT,
blade holder
1.5 mm**Z69****Item no.:** 5204302**Type**

Oscillating blade – flat

Properties

Blade for sandwich materials

Recommended materials

- Sandwich board
- Corrugated cardboard
- Corrugated plastic

Technical information

Pre-cut: 1.7 + 0.11 x Tm

Post-cut: -

Max. cutting depth: 35 mm

Blade thickness: 1.5 mm

Blade material: Carbide

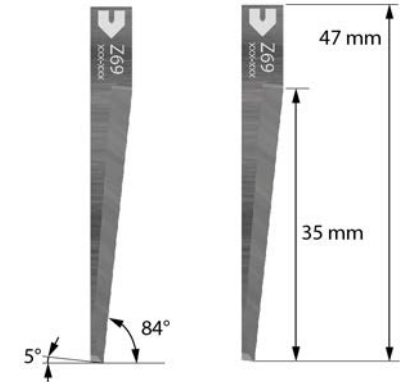
**Intended use**

EOT-250

POT,
blade holder
1.5 mm

Z607**Item no.:** 5210317**Type**

Oscillating blade – flat

Properties

Oscillating blade for soft foam up to 54 mm thickness and <math>45 \text{ kg/m}^3</math>

Recommended materials

– Foam

Technical informationPre-cut: $3.8 + 0.03 \times T_m$

Post-cut: -

Max. cutting depth: 56 mm

Blade thickness: 1.5 mm

Blade material: HSS

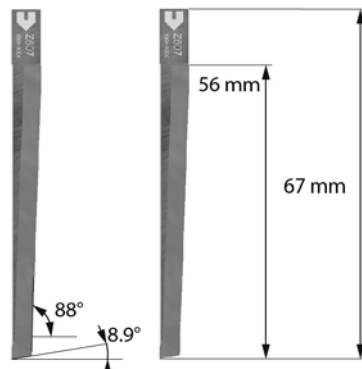
**Intended use**

EOT-250

POT, blade holder 1.5 mm +
gliding disc (5205984) +
spring insert low (3120030)**Z64****Item no.:** 5002739**Type**

Oscillating blade – flat

PropertiesCost-effective blade for soft, thick materials.
Short life expectancy!**Recommended materials**

– Foam

– Insulating mat

Technical informationPre-cut: $3.5 + 0.03 \times T_m$

Post-cut: -

Max. cutting depth: 57 mm

Blade thickness: 1.5 mm

Blade material: HSS

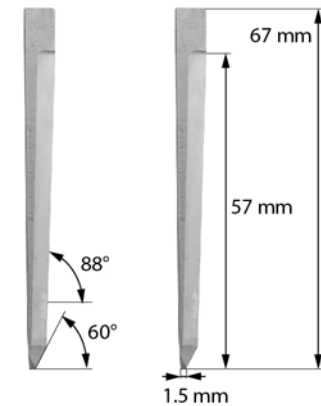
**Intended use**POT,
blade holder
1.5 mm

Z605**Item no.:** 5210319**Type**

Oscillating blade – flat

Properties

Oscillating blade for soft foam up to 70 mm thickness and <math> < 45 \text{ kg/m}^3 </math>

Recommended materials

– Foam

Technical informationPre-cut: $3.8 + 0.03 \times Tm$

Post-cut: -

Max. cutting depth: 72 mm

Blade thickness: 1.5 mm

Blade material: HSS

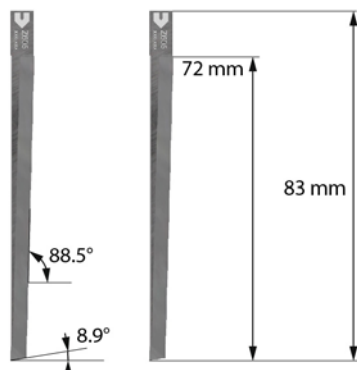
**Intended use**

EOT-250

POT, blade holder 1.5 mm +
gliding disc (5205984) +
spring insert low (3120030)**Z603****Item no.:** 5210320**Type**

Oscillating blade – flat

Properties

Oscillating blade for soft foam up to 90 mm thickness and <math> < 45 \text{ kg/m}^3 </math>

Recommended materials

– Foam

Technical informationPre-cut: $3.8 + 0.02 \times Tm$

Post-cut: -

Max. cutting depth: 92 mm

Blade thickness: 1.5 mm

Blade material: HSS

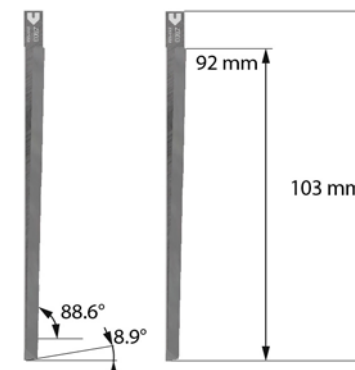
**Intended use**

EOT-250

POT, blade holder 1.5 mm +
gliding disc (5205984) +
spring insert low (3120030)

Z601**Item no.:** 5209223**Type**

Oscillating blade – flat

Properties

Oscillating blade for soft foam up to 110 mm thickness and <math>45 \text{ kg/m}^3</math>

Recommended materials

– Foam

Technical informationPre-cut: $3.8 + 0.02 \times T_m$

Post-cut: -

Max. cutting depth: 112 mm

Blade thickness: 1.5 mm

Blade material: HSS

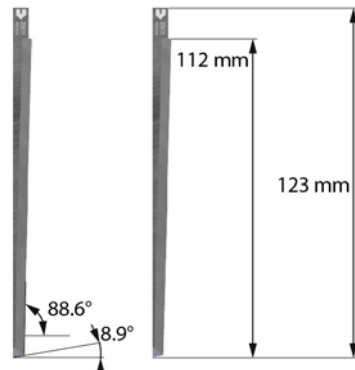
**Intended use**

EOT-250

POT, blade holder 1.5 mm +
gliding disc (5205984) +
spring insert low (3120030)**2.3.3 Rotary blade****Z50****Item no.:** 3910335**Type**

Rotary blade

PropertiesDecagonal (10-sided) blade similar to Z51/
Z52, but with smaller overcut and greater
cutting force.**Recommended materials**

- Textiles
- Technical textiles
- Carbon fibre
- Glass fibre
- Aramid fibre

Technical information

Max. cutting depth: 3.5 mm

Blade thickness: 0.6 mm

Blade material: Carbide

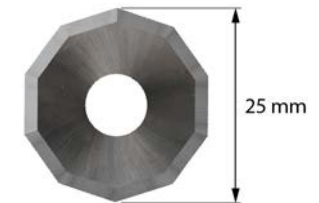
**Intended use**

DRT



PRT

Z51

Item no.: 3910336

Type

Rotary blade

Technical information

Max. cutting depth: 5.0 mm

Blade thickness: 0.6 mm

Blade material: Carbide

Properties

Decagonal (10-sided) blade.

Recommended materials

- Textiles
- Technical textiles
- Carbon fibre
- Glass fibre
- Aramid fibre

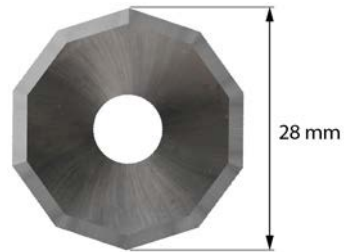

Intended use



DRT



PRT

Z52

Item no.: 3910337

Type

Rotary blade

Technical information

Max. cutting depth: 7.0 mm

Blade thickness: 0.6 mm

Blade material: Carbide

Properties

Decagonal (10-sided) blade similar to Z50/Z51, but with larger overcut and lower cutting force.

Recommended materials

- Textiles
- Technical textiles
- Carbon fibre
- Glass fibre
- Aramid fibre

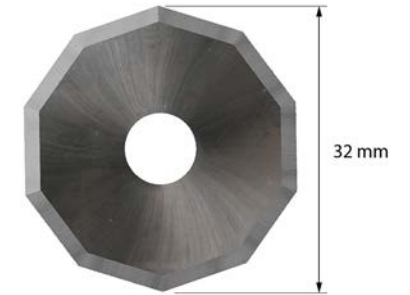

Intended use



DRT



PRT

Z53

Item no.: 4800059

Type

Rotary blade

Technical information

Max. cutting depth: 2.0 mm

Blade thickness: 0.6 mm

Blade material: Carbide

Properties

Driven round-knife for cutting of single-layer textiles.

Recommended materials

- Aramid fibre
- Glass fibre
- Single-layer textiles
- Textiles

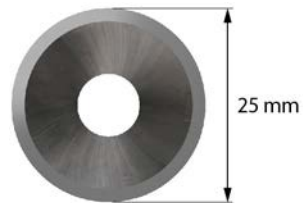
**Intended use**

DRT



PRT

2.3.4 Wheel knives**Z55**

Item no.: 5205751

Type

Wheel knife

Technical information

Max. cutting depth: 1 mm (single-layer)

Blade thickness: 0.3 mm

Blade material: HSS

Properties

Only use with a special PU cutting underlay.

Recommended materials

- Technical textiles (PES, PVC, etc.)
- Carbon fibre
- Glass fibre

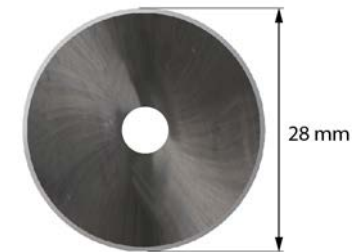
**Intended use**

WKT

2.4 Wild knives

Item no.	Knife
3910151	W1 40/35° single-edged
3910152	W2 30/35° single-edged
3910153	W5 30/30° double-edged
3910155	W7 30/35° single-edged long
3910156	W8 30/30° double-edged long
3910157	W9 30/45° single-edged long
3910158	WILD type 1 40/35° single-edged
3910159	WILD type 2 30/35° single-edged
3910160	WILD type 3 40/30° double-edged
3910161	WILD type 4 30/55° single-edged
3910322	Z40 HSS for EOT/POT tools

3 Router

3.1 RM-A / RM-A QC / RM-A QC ARC / RM-S / R45-s

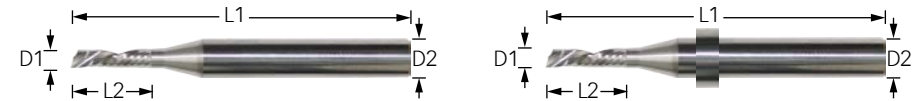

RXXX-A with stop ring (A-Version)

3.1.1 Zünd multipurpose router^{1,2}

Item no.	Type	D1 [mm]	D2 [mm]	Cutting	L1 [mm]	L2 [mm]	Max. rpm	Special	RM-A	RM-A QC	RM-A QC ARC	RM-S	R45-S
5211434	R202-A	2	6	1	58	6	50000	A-Version	•	•	•	•	•
5211435	R203-A	3	6	1	58	11	50000	A-Version	•	•	•	•	•
5211436	R204-A	4	6	1	58	14	46600	A-Version	•	•	•	•	•
5211437	R205-A	5	6	1	58	16	37200	A-Version	•	•	•	•	•
5211438	R206-A	6	6	1	58	22	31000	A-Version	•	•	•	•	•

¹ Acrylic, aluminum, Dibond, Forex, MDF, Pertinax, and plastics like PET, PP, PE, PVC-U, PS.

² Routers specially developed for Zünd Cutters. Suitable for hard as well as soft materials.

3.1.2 Acrylic, Aluminium

Item no.	Type	D1 [mm]	D2 [mm]	Cutting	L1 [mm]	L2 [mm]	Max. rpm	Special	RM-A	RM-A QC	RM-A QC ARC	RM-S	R45-s
3910742	R102	2	6	1	50	6	50000		•	•		•	•
3910738	R108	3	6	1	50	6	50000		•	•		•	•
3910743	R103	3	6	1	50	11	50000		•	•		•	•
3910739	R109	4	6	1	50	6	46600		•	•		•	•
3910744	R104	4	6	1	50	14	46600		•	•		•	•
3910793	R170	4	6	1	50	22	46600		•	•		•	•
3910773	R173	5	6	1	50	16	37200		•	•		•	•
3910794	R171	5	6	1	58	22	37200		•	•		•	•
3910740	R101	6	6	1	50	12	31000		•	•		•	•
3910741	R100	6	6	1	58	22	31000		•	•		•	•
3910798	R172	6	6	1	64	32	31000		•	•		•	•
3910747	R123	3	6	1	50	11	50000	left-hand spiral bits	•	•		•	•
3910748	R124	4	6	1	50	12	46600	left-hand spiral bits	•	•		•	•
3910749	R125	5	6	1	50	12	37200	left-hand spiral bits	•	•		•	•
3910750	R126	6	6	1	60	22	31000	left-hand spiral bits	•	•		•	•
5211741	R123-A	3	6	1	50	11	50000	left-hand spiral bits, A-Version		•	•		
5211742	R124-A	4	6	1	50	12	46600	left-hand spiral bits, A-Version		•	•		
5211743	R126-A	6	6	1	60	22	31000	left-hand spiral bits, A-Version		•	•		

3.1.3 Forex, MDF, Wood, Dibond

Item no.	Type	D1 [mm]	D2 [mm]	Cutting	L1 [mm]	L2 [mm]	Max. rpm	Special	RM-A	RM-A QC	RM-A QC ARC	RM-S	R45-s
3910762	R112	2	6	1	50	6	50000		•	•		•	•
3910761	R153	3	6	1	50	6	50000		•	•		•	•
3910763	R113	3	6	1	50	11	50000		•	•		•	•
3910709	R154	4	6	1	50	8	46600		•	•		•	•
3910764	R114	4	6	1	50	12	46600		•	•		•	•
3910795	R157	4	6	1	50	14	46600		•	•		•	•
3910796	R158	4	6	1	50	22	46600		•	•		•	•
3910758	R115	5	6	1	50	16	37200		•	•		•	•
3910797	R159	5	6	1	58	22	37200		•	•		•	•
3910759	R116	6	6	1	58	22	31000		•	•		•	•
3910771	R117	6	6	1	56	28	31000		•	•		•	•
3910710	R156	6	6	1	64	32	31000		•	•		•	•
3910767	R133	3	6	1	50	11	50000	left-hand spiral bits	•	•		•	•
3910768	R134	4	6	1	50	14	46600	left-hand spiral bits	•	•		•	•
3910769	R135	5	6	1	50	16	37200	left-hand spiral bits	•	•		•	•
3910770	R136	6	6	1	60	22	31000	left-hand spiral bits	•	•		•	•
5211744	R133-A	3	6	1	50	11	50000	left-hand spiral bits, A-Version		•	•		
5211745	R134-A	4	6	1	50	14	46600	left-hand spiral bits, A-Version		•	•		
5211746	R136-A	6	6	1	60	22	31000	left-hand spiral bits, A-Version		•	•		

3.1.4 Light foam < 52 kg/m³

Item no.	Type	D1 [mm]	D2 [mm]	Cutting	L1 [mm]	L2 [mm]	Max. rpm	Special	RM-A	RM-A QC	RM-A QC ARC	RM-S	R45-s
3910726	R118	6	6	2	75	27	48000	2-flute	•				
3910727	R119	6	6	2	100	40	48000	2-flute	•				
3910728	R120	6	6	2	100	53	25000	2-flute	•				
5211733	R118-A	6	6	2	75	27	48000	2-flute, A-Version		•	•		
5211734	R219-A	6	6	2	85	40	48000	2-flute, A-Version		•	•		
5211735	R220-A	6	6	2	90	53	25000	2-flute, A-Version		•	•		

3.1.5 Engraving bit

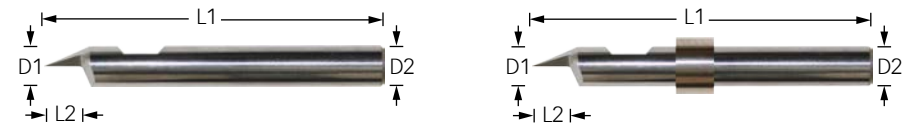

EX-A with stop ring (A-Version)

Item no.	Type	D1 [mm]	D2 [mm]	Cutting	L1 [mm]	L2 [mm]	Brackets	Max. rpm	Special	RM-A	RM-A QC	RM-A QC ARC	RM-S	R45-s
3910506	E6	6	6	1	50	2.7	92°	50000	Acrylic, plastic	•	•		•	•
3910507	E7	6	6	1	50	4.7	60°	50000	Acrylic, plastic	•	•		•	•
3910508	E8	6	6	1	50	7.5	40°	50000	Acrylic, plastic	•	•		•	•
5211747	E6-A	6	6	1	50	2.7	92°	50000	A-Version		•	•		
5211748	E7-A	6	6	1	50	4.7	60°	50000	A-Version		•	•		
5211749	E8-A	6	6	1	50	7.5	40°	50000	A-Version		•	•		

3.1.6 V-shape

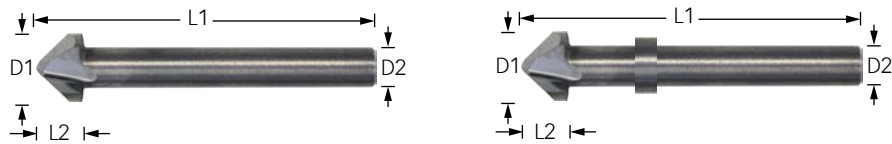

RXXX-A with stop ring (A-Version)

Item no.	Type	D1 [mm]	D2 [mm]	Cutting	L1 [mm]	L2 [mm]	Brackets	Max. rpm	Special	RM-A	RM-A QC	RM-A QC ARC	RM-S	R45-s
3910799	R141	10	6	2	50	4	90°	40000	Acrylic, Dibond	•	•		•	•
5211751	R141-A	10	6	2	50	4	90°	40000	Acrylic, Dibond, A-Version		•	•		

3.1.7 Polisher

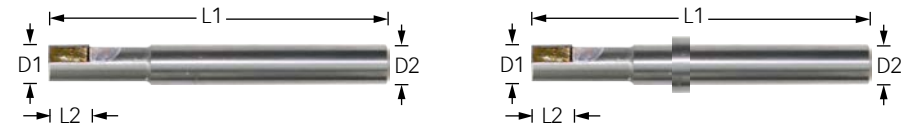

PXXX-A with stop ring (A-Version)

Item no.	Type	D1 [mm]	D2 [mm]	Cutting	L1 [mm]	L2 [mm]	Max. rpm	Special	RM-A	RM-A QC	RM-A QC ARC	RM-S	R45-s
3910780	P106	6	6	1	50	6	41000	Acrylic, Diamond-polisher	•	•		•	•
5211750	P106-A	6	6	1	50	6	41000	Acrylic, A-Version		•	•		

3.1.8 Custom router bits



Item no.	Type	D1 [mm]	D2 [mm]	Cutting	L1 [mm]	L2 [mm]	Max. rpm	Special	RM-A	RM-A QC	RM-A QC ARC	RM-S	R45-s
3910452	R62	2.4	1/8"	2	38	10	-	Pertinax					•

3.2 URT 300 W / PN 150/450 W



3.2.1 Acrylic, Aluminium

Item no.	Type	D1 [mm]	D2 [mm]	Cutting	L1 [mm]	L2 [mm]	Max. rpm	Special	URT	PN 150/450 W
3910730	R40	1	3	1	38	4	80000		•	•
3910734	R41	2	3	1	38	6	80000		•	•
3910735	R42	3	3	1	38	6	62000		•	•
3910737	R43	3	3	1	38	11	62000		•	•
3910700	R5	2	3	1	38	4	80000	left hand spiral bits	•	•
3910736	R44	3	3	1	38	6	62000	left hand spiral bits	•	•
3910705	R25	0.6	1/8"	2	38	3	-	2-flute		•
3910706	R26	0.8	1/8"	2	38	4.5	-	2-flute		•
3910707	R27	1	1/8"	2	38	4.5	-	2-flute		•
3910708	R28	1.2	1/8"	2	38	6	-	2-flute		•
3910701	R21	1.6	1/8"	2	38	8	-	2-flute		•
3910702	R22	2	1/8"	2	38	9	-	2-flute		•
3910703	R23	2.4	1/8"	2	38	9	-	2-flute		•
3910704	R24	3	1/8"	2	38	10	-	2-flute		•
3910718	R50	4	4	1	50	14	46000			•

3.2.2 Forex, MDF, Wood, Dibond

Item no.	Type	D1 [mm]	D2 [mm]	Cutting	L1 [mm]	L2 [mm]	Max. rpm	Special	URT	PN 150/450 W
3910752	R71	1	3	1	30	4	80000		•	•
3910753	R72	2	3	1	30	6	80000		•	•
3910755	R74	3	3	1	30	6	63600		•	•
3910756	R75	3	3	1	38	11	63600		•	•
3910754	R73	2	3	1	38	6	80000	left hand spiral bits	•	•
3910757	R76	3	3	1	38	11	63600	left hand spiral bits	•	•
3910715	R15	0.6	1/8"	1	38	2.5	-			•
3910716	R16	1	1/8"	1	38	4	-			•
3910717	R17	1.2	1/8"	1	38	5	-			•
3910711	R11	1.6	1/8"	1	38	5.5	-			•
3910712	R12	2	1/8"	1	38	9.5	-			•
3910713	R13	2.4	1/8"	1	38	9.5	-			•
3910714	R14	3	1/8"	1	38	9.5	-			•
3910720	R52	4	4	1	50	12	46600			•
3910719	R51	4	4	1	50	22	46600			•

3.2.3 Light foam < 52 kg/m³

Item no.	Type	D1 [mm]	D2 [mm]	Cutting	L1 [mm]	L2 [mm]	Max. rpm	Special	URT	PN 150/450 W
3910729	R121	3	3	2	75	25	-	2-flute		•

3.2.4 Hard Brass

Item no.	Type	D1 [mm]	D2 [mm]	Cutting	L1 [mm]	L2 [mm]	Max. rpm	Special	URT	PN 150/450 W
3910424	R34	1	3	3	38	3	-	3-flute		•
3910421	R31	1.5	3	3	38	5	-	3-flute		•
3910422	R32	2	3	3	38	6	-	3-flute		•
3910425	R35	2.5	3	3	38	7	-	3-flute		•
3910423	R33	3	3	3	38	9	-	3-flute		•

3.2.5 Engraving bit

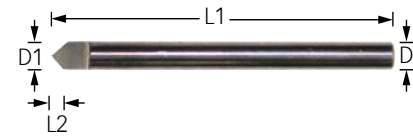

Item no.	Type	D1 [mm]	D2 [mm]	Cutting	L1 [mm]	L2 [mm]	Brackets	Max. rpm	Special	URT	PN 150/450 W
3910503	E3	3	3	1	38	3.9	36°	-	Engraving plates	•	•
3910509	E9	3	3	1	38	2.1	60°	-	Acrylic, Plastic	•	•
3910501	E1	3	3	1	38	1.3	90°	-	Acrylic, Plastic	•	•
3910502	E2	3	3	1	38	1.3	90°	-	Brass	•	•
3910505	E5	3	1/8"	1	38	2.1	60°	-	Acrylic, Plastic		•
3910504	E4	3	1/8"	1	38	1.3	90°	-	Acrylic, Plastic		•

3.2.6 Custom router bits



Item no.	Type	D1 [mm]	D2 [mm]	Cutting	L1 [mm]	L2 [mm]	Max. rpm	Special	URT	PN 150/450
3910452	R62	2.4	1/8"	2	38	10	-	Pertinax		•

4 Creasing wheels

4.1 Creasing wheels type 1

Figure	Item no.	Item
	5005632	Creasing wheel C101 without holder
	5005633	Creasing wheel C102 without holder
	5005634	Creasing wheel C103 without holder

Creasing wheels

Creasing wheels type 2

4.2 Creasing wheels type 2

4.2.1 Solid cardboard

Figure	Item no.	Item
	3910603	Creasing wheel C201, with holder
	3910604	Creasing wheel C202, with holder
	5002277	Creasing wheel C203, with holder
	5002275	Creasing wheel C204, with holder
	3910601	Creasing wheel C205, with holder

Creasing wheels

Creasing wheels type 1

Figure	Item no.	Item
	3910602	Creasing wheel C206, with holder
	3910611	Creasing wheel C207, with holder
	3910612	Creasing wheel C208, with holder

4.2.2 Corrugated cardboard

Figure	Item no.	Item
	5003247	Creasing wheel C209, with holder

Creasing wheels

Creasing wheels type 1

4.2.3 Polypropylene, special materials

Figure	Item no.	Item
	5002540	Creasing tool C001, without holder
	5002541	Creasing tool C002, without holder
	3910607	Creasing tool C214, with holder
	3910606	Creasing wheel C210, with holder
	3910605	Creasing wheel C211, with holder
	5003245	Creasing wheel C212, with holder

Creasing wheels

Creasing wheels type 1

Figure	Item no.	Item
	5003246	Creasing wheel C213, with holder

Creasing wheels

Creasing wheels type 3

4.3 Creasing wheels type 3

Figure	Item no.	Item
	5205823	Creasing wheel C301, without holder
	5205824	Creasing wheel C302, without holder
	5210477	Creasing wheel C303, without holder
	5210490	Creasing wheel C304, without holder

Punching tools

HSS punches

5 Punching tools

5.1 HSS punches

Figure	Item no.	Punch Ø [mm]	Tool holder Ø [mm]
	3999211	0.5	7
	3999213	0.8	7
	3999201	1	7
	3999200	1.2	7
	3999202	1.5	7
	3999203	2	7
	3999204	2.5	7
	3999205	3	7
	3999206	3.5	7
	3999207	4	7
	3999208	4.5	7
	3999209	5	7
	3999210	5.5	7



Punching tools

Carbide punches

5.2 Carbide punches

Figure	Item no.	Punch Ø [mm]	Tool holder Ø [mm]
	3999101	1	4.5
	3999102	1.5	4.5
	3999103	2	4.5
	3999104	2.5	4.5
	3999105	3	7
	3999106	3.5	7
	3999107	4	7
	3999108	4.5	7
	3999109	5	7

5.3 Punching pins

Figure	Item no.	Tool holder Ø [mm]
	3999111	4.5
	3999112	7

Tools [insert sleeves]

Carbide punches

6 Tools [insert sleeves]

Figure	Item no.	Item
	5206113	UCT, CTT2 [insert sleeve 40 for Tz-Module complete with glide shoe; does not include blade holder]
	5206112	UCT, CTT2 [insert sleeve 40 for Tz-Module; does not include glide shoe; creasing tool holder does not include blade holder]
	3102202	KCT [insert sleeve 40 for Tz-module for vinyl cutting (spring can be used to adjust downward pressure)]
	3120133	UDT [Pen insert sleeve 40 for Tz-module]
	3120098	Insert sleeve 28 for 2T-module; does not include glide shoe (for Tz-2T-P tool heads)
	5005638	CTT1 [creasing wheel holder]
	5205846	CTT3 [creasing wheel holder]

7 Cutting accessories

Figure	Item no.	Item
	3620106	Spring insert, blue (spring tension 0.24 - 0.96 N) for KCT/CP/sleeve 40 (guided)
	3620107	Spring insert, red (spring tension to 2.8 N) for KCT/CP/sleeve 40 (guided)
	3620108	Spring insert, yellow (spring tension to 7 N) for KCT/CP/sleeve 40 (guided)
	3620117	Spring insert, special (spring tension to 20 N) for KCT/CP/sleeve 40 (guided)
	5003138	blade reduction 1.5/0.6 mm for POT-40/1.5; enables the use of blades with 0.63 mm shank thickness (Z20, Z41, etc.)
	5003139	blade reduction 1.5/1.0 mm for POT-40/1.5; enables the use of blades with 1 mm shank thickness
	5206051	2 guide rails, WKT Ø 5/18 mm

7.1 Blade holder, flat-stock drag blade

Figure	Item no.	Item
	3960322	Type 1 (silver) for centric blades, 1.5 mm thick (Z10, Z11, Z44)
	3960323	Type 2 (blue) for centric blades, 0.63 mm thick (Zünd type 2, Zünd type 3)
	3960324	Type 3 (yellow) for eccentric blades, 0.63 mm thick (Z16, Z17)
	3960320	Type 5 for eccentric blades, 1.5 mm thick (Z46)
	5002251	Type 1 (silver) [goes with insert sleeve 28 for 2T-module (Z10, Z11, etc.)]
	5002252	Type 2 (blue) [goes with insert sleeve 28 for 2T-module (Zünd type 2, Zünd type 3, etc.)]
	5002253	Type 3 (yellow) [goes with insert sleeve 28 for 2T-module (Z16, Z17, etc.)]

Cutting accessories



Blade holder, V-cut blade

7.2 Blade holder, V-cut blade





Figure	Item no.	Item
	5005928	Blade holder 16 mm compl.; goes with trapeze blade (VCT G3)
	5005929	Blade holder 10 mm compl.; goes with carbide blade (VCT G3)
	5005930	Blade holder 16 mm compl.; goes with carbide blade (VCT G3)

Cutting accessories



Blade holder, V-cut blade

Figure	Item no.	Item
	5206262	Blade holder 16 mm compl.; goes with trapeze blade (VCT S3/G3)
	5206264	Blade holder 16 mm compl.; goes with carbide blade (VCT S3/G3)
	5206263	Blade holder 10 mm compl.; goes with carbide blade (VCT S3/G3)

7.3 Blade holder, PPT blade

Figure	Item no.	Item
	3960331	Knife holder for PPT; for Z30/Z31
	3960328	Knife holder for PPT up to 5 mm; for Z33
	3960329	Knife holder for PPT up to 2.5 mm; for Z33
	3960330	Knife holder for PPT; for Z35

7.4 EOT

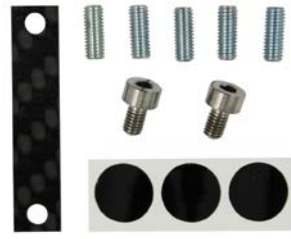
Figure	Item no.	Item
	5005885	Blade guide (EOT)
	5201162	Bearing (EOT)
	5901424	5 set screws, EOT blade holder
	5200665	Service set 2, connecting rod

7.5 EOT-250

Figure	Item no.	Item
	5208744	Knife holder 0.6 mm
	5208751	Knife holder 1.5 mm
	5208745	Service set
	5210884	Friction bearing
	5204325	Bearing

7.6 Glide shoes

Figure	Item no.	Item
	3120026	Gliding shoe, 4 mm spring deflection (EOT-40, EOT-3)
	5811445	Gliding shoe, 8 mm spring deflection (UCT)
	3120029	Gliding shoe, rigid (UCT, SCT)
	5205984	Gliding shoe, 12 mm spring deflection, metal (POT+Z82)



Cutting accessories

Glide shoes

Figure	Item no.	Item
	5811541	Gliding shoe, 12 mm spring deflection (POT, EOT)
	3120143	Gliding shoe, height-adjustable (POT, EOT)
	5002146	Rigid glide shoe [2T-sleeve 28]
	3120021	Glide shoe for blade holder (KCT) [C2/vinyl insert]

Cutting accessories

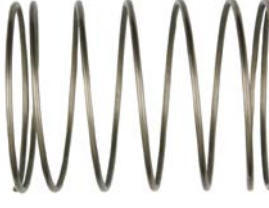
Glide shoes

Figure	Item no.	Item
	3120030	Spring insert – low-strength
	3120031	Spring insert – medium-strength
	3120032	Spring insert – high-strength

Cutting accessories

KCM-S, C2-, C2-P tool heads

7.7 KCM-S, C2-, C2-P tool heads

Figure	Item no.	Item
	3910130	ZÜND type blade changer (for blade types Z1-Z5)
	3120013	Cartridge holder for KCM-S, C2
	3120011	blade holder for KCM-S, C2, C2-P tool head (for vinyl blades)
	3120012	blade holder for KCM-S, C2, C2-P tool heads with glide shoe, suitable for "Diamond Grade" vinyl
	3120018	Ejector pin for sleeve, C2/KCM-S

Routing accessories

Collets, 1 kW milling spindle

8 Routing accessories

8.1 Collets, 1 kW milling spindle

Figure	Item no.	Description
	3910500	Ø 1/8 " (3.175 mm)
	3910497	Ø 1/4 " (6.35mm)
	3910498	Ø 3.0 mm
	3910499	Ø 4.0 mm
	3910496	Ø 6 mm

8.2 Collets, 1 kW milling spindle, QC

Figure	Item no.	Description
	5812106	Ø 6.0 mm





8.3 Collets, 300 W milling spindle

Figure	Item no.	Description
	3910491	Ø 3.0 mm

Routing accessories

Collets, 150/450 W milling spindle

8.4 Collets, 150/450 W milling spindle

Figure	Item no.	Description
	3910492	Ø 1/8 " (3.175 mm)
	3910494	Ø 2.0 mm
	1527491	Ø 2.5 mm
	3910491	Ø 3.0 mm
	3910493	Ø 4.0 mm

Routing accessories

Consumables







8.5 Consumables

Figure	Item no.	Description
	3621213	Brush, router types RZP, R45, R module, URT
	5005271	Brush, milling type R45s, RM-A
	5202125	MQL lubricant, Accu-Lube LB4500, 1-litre container
	3621210	Glide shoe for suction bell (RM-A) [R-/R45-module]
	5211032	Clamping pin for pneumatic collet, Ø 6.0 mm
	5812569	Cylindric wiper, Ø 6.0 mm







Figure	Item no.	Description
	5210057	Router bit holder silver, Ø 9.0 mm
	5210058	Router bit holder black, Ø 10.5 mm
	5210059	Router bit holder red, Ø 10.0 mm

9 Plotting accessories

9.1 Insert sleeves, cartridges/cartridge holders

Figure	Item no.	Description
	3910223	Insert sleeve for long-life cartridge (Super Giant)
	3910222	Insert sleeve for silver cartridge
	1384482	Insert sleeve for pencil
	3205430	Insert sleeve for edding 400/404 (permanent marker)
	5202649	Insert sleeve for edding 1880/140s
	3910200	Insert sleeve for ballpoint cartridge
	3912218	Insert sleeve for ink cartridge (standard)

9.2 Cartridges

Figure	Item no.	Item
	3910201	Ballpoint cartridge black
	3910202	Ballpoint cartridge blue
	3910203	Ballpoint cartridge green
	3910204	Ballpoint cartridge red
	3910224	Long-life cartridge black (Super Giant)
	3910205	Ballpoint cartridge silver

9.3 Ink pens

Figure	Item no.	Item
	3912223	Ink pen 0.18 mm
	3912224	Ink pen 0.25 mm
	3912225	Ink pen 0.35 mm
	3912215	Vinyl pen black (22 ml)

10 Cutting and routing underlays

10.1 Sealgrip routing underlay

Item no.	Item	Size [mm]
5200362	Sealgrip routing underlay	1000 x 1600
3912208	Sealgrip routing underlay, 30 m x 1 m roll	

10.2 G3 series

10.2.1 Cutting underlay PLP (anthracite)

Item no.	Cutter	Size [mm]
3930010	M-1600	1410 x 1984, 2-part
3930002	M-2500	1410 x 2883, 3-part
3930001	L-2500	1880 x 2884, 4-part
3930004	L-3200	1880 x 3582, 6-part
3930009	XL-1600	2350 x 1984, 4-part
3930003	XL-3200	2350 x 3584, 8-part
3930008	2XL-1600	2820 x 1984, 4-part
3930007	2XL-3200	2820 x 3584, 8-part
3930005	3XL-1600	3288 x 1984, 6-part
3930011	3XL-2500	3288 x 2884, 8-part
3930006	3XL-3200	3288 x 3584, 12-part

Cutting and routing underlays

S3 series

10.2.2 Cutting underlay PU (red)

Item no.	Cutter
3940010	M-1600
3940002	M-2500
3940001	L-2500
3940004	L-3200

10.3 S3 series

10.3.1 Cutting underlay PLP (anthracite)

Item no.	Cutter	Size [mm]
3934001	M-800	1410 x 1184, 2-teilig
3934002	M-1200	1410 x 1584, 2-teilig
3934010	M-1600	1410 x 1984, 2-teilig
3934004	L-1200	1880 x 1584, 4-teilig
3934005	L-1600	1880 x 1984, 4-teilig
3934006	XL-1200	2350 x 1584, 4-teilig

10.4 L3 series

Item no.	Item
3936001	C-40, cutting underlay S (anthracite), 2.5 mm
3936002	C-56, cutting underlay S (anthracite), 2.5 mm

Cutting and routing underlays

PN series

10.5 PN series

10.5.1 S-800

Item no.	Item	Size [mm]; quantity/set
3912140	Cutting/routing underlay PLP (anthracite), 2.5mm	940 x 870
3912143	Cutting underlay ST (brown), 1.0 mm	940 x 870
3912147	Cutting underlay S (anthracite), 2.7 mm	940 x 870

10.5.2 M-800

Item no.	Item	Size [mm]; quantity/set
3912120	Cutting/routing underlay PLP (anthracite), 2.5mm	1380 x 870
3912125	Cutting underlay ST (brown), 1.0 mm	1380 x 870
3912150	Cutting underlay S (anthracite), 2.7 mm	1380 x 870
3912174	Cutting underlay S (anthracite), 4 mm	1380 x 870

10.5.3 M-1200

Item no.	Item	Size [mm]; quantity/set
3912121	Cutting/routing underlay PLP (anthracite), 2.5mm	1380 x 640, 2 pcs.
3912126	Cutting underlay ST (brown), 1.0 mm	1380 x 1280
3912151	Cutting underlay S (anthracite), 2.7 mm	1380 x 1280

10.5.4 M-1600

Item no.	Item	Size [mm]; quantity/set
3912122	Cutting/routing underlay PLP (anthracite), 2.5mm	1380 x 870, 2 pcs.

Cutting and routing underlays

PN series

Item no.	Item	Size [mm]; quantity/set
3912127	Cutting underlay ST (brown), 1.0 mm	1740 x 1380
3912152	Cutting underlay S (anthracite), 2.7 mm	1330 x 1700

10.5.5 L-800

Item no.	Item	Size [mm]; quantity/set
3912123	Cutting/routing underlay PLP (anthracite), 2.5mm	940 x 870, 2 pcs.
3912128	Cutting underlay ST (brown), 1.0 mm	1880 x 1060
3912153	Cutting underlay S (anthracite), 2.7 mm	1850 x 870

10.5.6 L-1200

Item no.	Item	Size [mm]; quantity/set
3912124	Cutting/routing underlay PLP (anthracite), 2.5mm	940 x 1290, 2 pcs.
3912129	Cutting underlay ST (brown), 1.0 mm	1879 x 1460
3912154	Cutting underlay S (anthracite), 2.7 mm	1849 x 1280

10.5.7 LR-1600

Item no.	Item	Size [mm]; quantity/set
3912135	Cutting/routing underlay PLP (anthracite), 2.5mm	940 x 870, 4 pcs.
3912141	Cutting underlay ST (brown), 1.0 mm	1800 x 1880
3912155	Cutting underlay S (anthracite), 2.7 mm	1850 x 1740

Cutting and routing underlays

PN series

10.5.8 LH-1600

Item no.	Item	Size [mm]; quantity/set
3912135	Cutting/routing underlay PLP (anthracite), 2.5mm	940 x 870, 4 pcs.
3912141	Cutting underlay ST (brown), 1.0 mm	1800 x 1880
3912155	Cutting underlay S (anthracite), 2.7 mm	1850 x 1740

10.5.9 L-2500

Item no.	Item	Size [mm]; quantity/set
3912136	Cutting/routing underlay PLP (anthracite), 2.5mm	940 x 1290, 4 pcs.
3912142	Cutting underlay ST (brown), 1.0 mm	1400 x 1880, 2 pcs.
3912156	Cutting underlay S (anthracite), 2.7 mm	1850 x 2580

10.5.10 L-3000

Item no.	Item	Size [mm]; quantity/set
3912164	Cutting/routing underlay PLP (anthracite), 2.5mm	940 x 1100, 6 pcs.
3912165	Cutting underlay ST (brown), 1.0 mm	1650 x 1880, 2 pcs.
3912166	Cutting underlay S (anthracite), 2.7 mm	1850 x 3300

10.5.11 XL-800

Item no.	Item	Size [mm]; quantity/set
3912137	Cutting/routing underlay PLP (anthracite), 2.5mm	1140 x 870, 2 pcs.
3912132	Cutting underlay ST (brown), 1.0 mm	2280 x 1060
3912157	Cutting underlay S (anthracite), 2.7 mm	2250 x 870

Cutting and routing underlays

PN series

10.5.12 XL-1200

Item no.	Item	Size [mm]; quantity/set
3912138	Cutting/routing underlay PLP (anthracite), 2.5mm	1140 x 640, 4 pcs.
3912133	Cutting underlay ST (brown), 1.0 mm	2280 x 1460
3912158	Cutting underlay S (anthracite), 2.7 mm	2250 x 1280

10.5.13 XL-1600

Item no.	Item	Size [mm]; quantity/set
3912134	Cutting/routing underlay PLP (anthracite), 2.5mm	1140 x 870, 4 pcs.
3912145	Cutting underlay ST (brown), 1.0 mm	1140 x 1960, 2 pcs.

10.5.14 XL-2500

Item no.	Item	Size [mm]; quantity/set
3912139	Cutting/routing underlay PLP (anthracite), 2.5mm	760 x 1400, 6 pcs.
3912146	Cutting underlay ST (brown), 1.0 mm	1400 x 2280, 2 pcs.
3912159	Cutting underlay S (anthracite), 2.7 mm	2250 x 2580

10.5.15 XL-3000

Item no.	Item	Size [mm]; quantity/set
3912167	Cutting/routing underlay PLP (anthracite), 2.5mm	820 x 1140, 8 pcs.
3912168	Cutting underlay ST (brown), 1.0 mm	1650 x 2280, 2 pcs.
3912169	Cutting underlay S (anthracite), 2.7 mm	2250 x 3300

Cutting and routing underlays

PN series

10.5.16 2XL-3000

Item no.	Item	Size [mm]; quantity/set
3912184	Cutting/routing underlay PLP (anthracite), 2.5mm	1393 x 825, 8 pcs.
3912170	Cutting underlay S (anthracite), 2.7 mm	2785 x 3300

10.5.17 3XL-3000

Item no.	Item	Size [mm]; quantity/set
3912186	Cutting underlay S (anthracite), 2.7 mm	1725 x 3300, 2 pcs.

Cutting and routing underlays

LC series

10.6 LC series

10.6.1 LC-2400

Item no.	Item	Size [mm]; quantity/set
3912171	Cutting/routing underlay PLP (anthracite), 2.5 mm	827 x 1100, 3 pcs.
3912160	Cutting underlay S (anthracite), 4 mm	1100 x 2480
5000532	Cutting/Router underlay PLP (brown), 4.5 mm	1100 x 2480
3912181	Cutting underlay S (anthracite), 2.5 mm	1049 x 2490

10.6.2 LC-1400

Item no.	Item	Size [mm]; quantity/set
3912112	Cutting/routing underlay PLP (anthracite), 2.5 mm	1499 x 773
3912148	Cutting underlay S (anthracite), 4 mm	795 x 1510

10.6.3 LC-1800

Item no.	Item	Size [mm]; quantity/set
3912111	Cutting/routing underlay PLP (anthracite), 2.5 mm	1499 x 773 + 416 x 773
3912149	Cutting underlay S (anthracite), 4 mm	795 x 1935

10.6.4 LC-2600

Item no.	Item	Size [mm]; quantity/set
3912113	Cutting/routing underlay PLP (anthracite), 2.5 mm	870 x 1380, 2 pcs. + 778 x 1380
3912161	Cutting underlay S (anthracite), 4 mm	1648 x 2760

Cutting and routing underlays

LC series

10.6.5 LC-5200

Item no.	Item	Size [mm]; quantity/set
3912114	Cutting/routing underlay PLP (anthracite), 2.5 mm	870 x 1380, 4 pcs. + 778 x 1380
3912162	Cutting underlay S (anthracite), 4 mm	1648 x 5520

10.6.6 LC-16/52

Item no.	Item	Size [mm]; quantity/set
3912172	Cutting underlay S (anthracite), 4 mm	1633 x 5348

10.6.7 LC-27/32

Item no.	Item	Size [mm]; quantity/set
3912163	Cutting underlay S (anthracite), 4 mm	1370 x 3280, 2 pcs.

Cutting and routing underlays

P series

10.7 P series

10.7.1 P-700

Item no.	Item	Size [mm]; quantity/set
3912101	Cutting/routing underlay PLP (anthracite), 2.5 mm	1100 x 830
3912105	Cutting underlay ST (brown), 1.0 mm	1100 x 830

10.7.2 P-1200

Item no.	Item	Size [mm]; quantity/set
3912102	Cutting/routing underlay PLP (anthracite), 2.5 mm	1100 x 665, 2 pcs.
3912106	Cutting underlay ST (brown), 1.0 mm	1330 x 1100

10.7.3 P-1600

Item no.	Item	Size [mm]; quantity/set
3912109	Cutting/routing underlay PLP (anthracite), 2.5 mm	1420 x 900, 2 pcs.
3912110	Cutting underlay ST (brown), 1.0 mm	1800 x 1420

10.7.4 P-2000

Item no.	Item	Size [mm]; quantity/set
3912107	Cutting/routing underlay PLP (anthracite), 2.5 mm	1380 x 870, 4 pcs.
3912108	Cutting underlay ST (brown), 1.0 mm	2570 x 1740

Cutting and routing underlays

Bulk materials

10.8 Bulk materials

Item no.	Item	Size [mm]; quantity/set
2500200	Cutting/routing underlay PLP (anthracite), 2.5 mm	1500 x 1000
2500201	Cutting underlay ST (brown), 1.0 mm	1800 x 20000

11 Conveyor belts

11.1 Accessories

Item no.	Item
5211233	Conveyor assembly glue, 50 ml (includes mixing jets and spatula)
3913000	Special conveyor assembly glue
3110997	Special fabric tape, 50 mm wide, 5 m long
5802298	Applicator gun

11.2 G3 series

11.2.1 M-1600

Item no.	Item
3923055	Conveyor belt, M-1600
3923056	Conveyor belt, M-1600 + M-CE800
3923057	Conveyor belt, M-1600 + M-CE800 + M-CE800
3923058	Conveyor belt, M-1600 + M-CE1600 + M-CE800
3923059	Conveyor belt, M-1600 + M-CE1600
3923060	Conveyor belt, M-1600+M-CE1600+M-CE1600

11.2.2 M-2500

Item no.	Item
3923002	Conveyor belt, M-2500
3923003	Conveyor belt, M-2500 + M-CE1250
3923004	Conveyor belt, M-2500 + M-CE2500
3923013	Conveyor belt, M-2500 + M-CE1250 + M-CE1250

Item no.	Item
3923014	Conveyor belt, M-2500 + M-CE2500 + M-CE2500
3923015	Conveyor belt, M-2500 + M-CE1250 + M-CE2500
3923061	Conveyor belt, M-2500 + 2xM-CE2500 front
3923062	Conveyor belt, M-2500+M-CE0800

11.2.3 L-2500

Item no.	Item
3923001	Conveyor belt, L-2500
3923005	Conveyor belt, L-2500 + L-CE1250
3923006	Conveyor belt, L-2500 + L-CE2500
3923016	Conveyor belt, L-2500 + L-CE1250 + L-CE1250
3923017	Conveyor belt, L-2500 + L-CE2500 + L-CE2500
3923018	Conveyor belt, L-2500 + L-CE1250 + L-CE2500

11.2.4 L-3200

Item no.	Item
3923007	Conveyor belt, L-3200
3923008	Conveyor belt, L-3200 + L-CE1600
3923009	Conveyor belt, L-3200 + L-CE3200
3924083	Conveyor belt, L-3200 + L-CE3500
3923019	Conveyor belt, L-3200 + L-CE1600 + L-CE1600
3923020	Conveyor belt, L-3200 + L-CE3200 + L-CE3200

Conveyor belts

G3 series

Item no.	Item
3924085	Conveyor belt, L-3200 + L-CE3500 + L-CE3500
3923021	Conveyor belt, L-3200 + L-CE1600 + L-CE3200
3924084	Conveyor belt, L-3200+L-CE3500+L-CE1600
3923080	Conveyor belt, L-3200+L-CE1250

11.2.5 XL-1600

Item no.	Item
3923025	Conveyor belt, XL-1600
3923026	Conveyor belt, XL-1600 + XL-CE800
3923030	Conveyor belt, XL-1600 + XL-CE1600
3923027	Conveyor belt, XL-1600 + XL-CE800 + XL-CE800
3923029	Conveyor belt, XL-1600 + XL-CE1600 + XL-CE1600
3923028	Conveyor belt, XL-1600 + XL-CE800 + XL-CE1600

11.2.6 XL-3200

Item no.	Item
3923010	Conveyor belt, XL-3200
3923011	Conveyor belt, XL-3200 + XL-CE1600
3923012	Conveyor belt, XL-3200 + XL-CE3200
3924086	Conveyor belt, XL-3200 + XL-CE3500
3923022	Conveyor belt, XL-3200 + XL-CE1600 + XL-CE1600
3923023	Conveyor belt, XL-3200 + XL-CE3200 + XL-CE3200
3924088	Conveyor belt, XL-3200 + XL-CE3500 + XL-CE3500

Conveyor belts

G3 series

Item no.	Item
3923024	Conveyor belt, XL-3200 + XL-CE1600 + XL-CE3200
3924087	Conveyor belt, XL-3200 + XL-CE1600 + XL-CE3500

11.2.7 2XL-1600

Item no.	Item
3923031	Conveyor belt, 2XL-1600
3923032	Conveyor belt, 2XL-1600 + 2XL-CE800
3923036	Conveyor belt, 2XL-1600 + 2XL-CE1600
3923033	Conveyor belt, 2XL-1600 + 2XL-CE800 + 2XL-CE800
3923035	Conveyor belt, 2XL-1600 + 2XL-CE1600 + 2XL-CE1600
3923034	Conveyor belt, 2XL-1600 + 2XL-CE800 + 2XL-CE1600

11.2.8 2XL-3200

Item no.	Item
3923037	Conveyor belt, 2XL-3200
3923038	Conveyor belt, 2XL-3200 + 2XL-CE1600
3923042	Conveyor belt, 2XL-3200 + 2XL-CE3200
3924089	Conveyor belt, 2XL-3200 + 2XL-CE3500
3923039	Conveyor belt, 2XL-3200 + 2XL-CE1600 + 2XL-CE1600
3923041	Conveyor belt, 2XL-3200 + 2XL-CE3200 + 2XL-CE3200
3924091	Conveyor belt, 2XL-3200 + 2XL-CE3500 + 2XL-CE3500
3923040	Conveyor belt, 2XL-3200 + 2XL-CE1600 + 2XL-CE3200
3924090	Conveyor belt, 2XL-3200 + 2XL-CE3500 + 2XL-CE1600

Conveyor belts

G3 series

11.2.9 3XL-1600

Item no.	Item
3923043	Conveyor belt, 3XL-1600
3923044	Conveyor belt, 3XL-1600 + 3XL-CE800
3923048	Conveyor belt, 3XL-1600 + 3XL-CE1600
3923045	Conveyor belt, 3XL-1600 + 3XL-CE800 + 3XL-CE800
3923047	Conveyor belt, 3XL-1600 + 3XL-CE1600 + 3XL-CE1600
3923046	Conveyor belt, 3XL-1600 + 3XL-CE800 + 3XL-CE1600

11.2.10 3XL-2500

Item no.	Item
3923063	Conveyor belt, 3XL-2500
3923064	Conveyor belt, 3XL-2500 + 3XL-CE1250
3923065	Conveyor belt, 3XL-2500 + 3XL-CE2500
3923066	Conveyor belt, 3XL-2500 + 3XL-CE1250 + 3XL-CE1250
3923067	Conveyor belt, 3XL-2500 + 3XL-CE2500 + 3XL-CE1250
3923068	Conveyor belt, 3XL-2500 + 3XL-CE2500 + 3XL-CE2500

11.2.11 3XL-3200

Item no.	Item
3923049	Conveyor belt, 3XL-3200
3923050	Conveyor belt, 3XL-3200 + 3XL-CE1600
3923054	Conveyor belt, 3XL-3200 + 3XL-CE3200
3924092	Conveyor belt, 3XL-3200 + 3XL-CE3500

Conveyor belts

G3 series

Item no.	Item
3923051	Conveyor belt, 3XL-3200 + 3XL-CE1600 + 3XL-CE1600
3923053	Conveyor belt, 3XL-3200 + 3XL-CE3200 + 3XL-CE3200
3924094	Conveyor belt, 3XL-3200 + 3XL-CE3500 + 3XL-CE3500
3923052	Conveyor belt, 3XL-3200 + 3XL-CE1600 + 3XL-CE3200
3924093	Conveyor belt, 3XL-3200 + 3XL-CE3500 + 3XL-CE1600

11.3 S3 series

11.3.1 M-800

Item no.	Item
3933001	Conveyor belt, M-800
3933002	Conveyor belt, M-800+M-CE800
3933003	Conveyor belt, M-800+M-CE800+M-CE800

11.3.2 M-1200

Item no.	Item
3933004	Conveyor belt, M-1200
3933005	Conveyor belt, M-1200+M-CE1200
3933006	Conveyor belt, M-1200+M-CE1200+M-CE1200

11.3.3 M-1600

Item no.	Item
3933007	Conveyor belt, M-1600
3933008	Conveyor belt, M-1600+M-CE1600
3933009	Conveyor belt, M-1600+M-CE1600+M-CE1600

11.3.4 L-1200

Item no.	Item
3933010	Conveyor belt, L-1200
3933011	Conveyor belt, L-1200+L-CE1200
3933012	Conveyor belt, L-1200+L-CE1200+L-CE1200

11.3.5 L-1600

Item no.	Item
3933013	Conveyor belt, L-1600
3933014	Conveyor belt, L-1600+L-CE1600
3933015	Conveyor belt, L-1600+L-CE1600+L-CE1600

11.3.6 XL-1200

Item no.	Item
3933016	Conveyor belt, XL-1200
3933017	Conveyor belt, XL-1200+XL-CE1200
3933018	Conveyor belt, XL-1200+XL-CE1200+XL-CE1200

11.4 D3 series

11.4.1 L-3200

Item no.	Item
3937001	Conveyor belt, D3 L-3200
3937002	Conveyor belt, D3 L-3200 + L-CE1600
3937003	Conveyor belt, D3 L-3200 + L-CE3500
3937004	Conveyor belt, D3 L-3200 + L-CE-1600 + L-CE1600
3937005	Conveyor belt, D3 L-3200 + L-CE-3500 + L-CE3500
3937006	Conveyor belt, D3 L-3200 + L-CE-1600 + L-CE3500

11.4.2 XL-3200

Item no.	Item
3937007	Conveyor belt, D3 XL-3200
3937008	Conveyor belt, D3 XL-3200 + XL-CE1600
3937009	Conveyor belt, D3 XL-3200 + XL-CE3500
3937010	Conveyor belt, D3 XL-3200 + XL-CE-1600 + XL-CE1600
3937011	Conveyor belt, D3 XL-3200 + XL-CE-3500 + XL-CE3500
3937012	Conveyor belt, D3 XL-3200 + XL-CE-1600 + XL-CE3500

11.4.3 2XL-3200

Item no.	Item
3937013	Conveyor belt, D3 2XL-3200
3937014	Conveyor belt, D3 2XL-3200 + 2XL-CE1600
3937015	Conveyor belt, D3 2XL-3200 + 2XL-CE3500

Item no.	Item
3937016	Conveyor belt, D3 2XL-3200 + 2XL-CE-1600 + 2XL-CE1600
3937017	Conveyor belt, D3 2XL-3200 + 2XL-CE-3500 + 2XL-CE3500
3937018	Conveyor belt, D3 2XL-3200 + 2XL-CE-1600 + 2XL-CE3500

11.4.4 3XL-3200

Item no.	Item
3937019	Conveyor belt, D3 3XL-3200
3937020	Conveyor belt, D3 3XL-3200 + 3XL-CE1600
3937021	Conveyor belt, D3 3XL-3200 + 3XL-CE3500
3937022	Conveyor belt, D3 3XL-3200 + 3XL-CE-1600 + 3XL-CE1600
3937023	Conveyor belt, D3 3XL-3200 + 3XL-CE-3500 + 3XL-CE3500
3937024	Conveyor belt, D3 3XL-3200 + 3XL-CE-1600 + 3XL-CE3500

Conveyor belts

PN series

11.5 PN series

11.5.1 S-800

Item no.	Item
3913011	Conveyor without CVE
3913100	Conveyor with CVE-08 – one side

11.5.2 M-800

Item no.	Item
3913021	Conveyor without CVE
3913073	Conveyor with CVE-08 – one side
3913054	Conveyor with CVE-12 – one side

11.5.3 M-1200

Item no.	Item
3913023	Conveyor without CVE
3913132	Conveyor with CVE-08 – one side
3913055	Conveyor with CVE-12 – one side

11.5.4 M-1600

Item no.	Item
3913025	Conveyor without CVE
3913082	Conveyor with CVE-12 – one side
3913076	Conveyor with CVE-16 – one side
3913027	Conveyor with CVE-16 – both sides

Conveyor belts

PN series

11.5.5 L-800

Item no.	Item
3913031	Conveyor without CVE
3913050	Conveyor with CVE-12 – one side

11.5.6 L-1200

Item no.	Item	Hint
3913039	Conveyor without CVE	< Serial number: L12009
3913033	Conveyor without CVE	> Serial number: L12008
3913051	Conveyor with CVE-12 – one side	
3913034	Conveyor with CVE-12 – both sides	

11.5.7 LR-1600

Item no.	Item
3913048	Conveyor without CVE
3913074	Conveyor with CVE-12 – one side
3913056	Conveyor with CVE-16 – one side
3913071	Conveyor with CVE-16 – both sides

11.5.8 LH-1600

Item no.	Item
3913035	Conveyor without CVE
3913057	Conveyor with CVE-16 – one side

11.5.9 L-2500

Item no.	Item	Hint
3913037	Conveyor without CVE	< Serial no. L25007
3913038	Conveyor without CVE	> Serial no. L25006
3913066	Conveyor with CVE-12 – one side	
3913058	Conveyor with CVE-25 – one side	
3913067	Conveyor with CVE-25 – both sides	

11.5.10 L-3000

Item no.	Item
3913061	Conveyor without CVE
3913087	Conveyor with CVE-12 – one side
3913063	Conveyor with CVE-25 – one side
3913089	Conveyor with CVE-30 – one side
3913086	Conveyor with CVE-30 – both sides

11.5.11 XL-800

Item no.	Item
3913041	Conveyor without CVE
3913052	Conveyor with CVE-12 – one side

11.5.12 XL-1200

Item no.	Item
3913043	Conveyor without CVE

Item no.	Item
3913053	Conveyor with CVE-12 – one side
3913088	Conveyor XL-1200 + CVE-12 + CVE-12

11.5.13 XL-1600

Item no.	Item
3913046	Conveyor without CVE
3913077	Conveyor with CVE-16 – one side

11.5.14 XL-2500

Item no.	Item
3913047	Conveyor without CVE
3913064	Conveyor with CVE-25 – one side
3913044	Conveyor belt with CVE-30
3913156	Conveyor with CVE-25 – both sides

11.5.15 XL-3000

Item no.	Item
3913049	Conveyor without CVE
3913153	Conveyor with CVE-12
3913151	Conveyor with CVE-16
3913065	Conveyor with CVE-25 – one side
3913103	Conveyor with CVE-30 – one side

Conveyor belts

PN series

11.5.16 2XL-3000

Item no.	Item
3913096	Conveyor without CVE
3913138	Conveyor with CVE-12 – one side
3913101	Conveyor with CVE-30 – one side
3913095	Conveyor with CVE-30 – both sides

11.5.17 3XL-3000

Item no.	Item
3913105	Conveyor without CVE
3913114	Conveyor with CVE-30 – one side

Headquarters
Zünd Systemtechnik AG

Industriestrasse 8
CH-9450 Altstätten
T +41 71 757 81 00
F +41 71 757 81 11
info@zund.com
www.zund.com

ZÜND 
swiss cutting systems